

Cordless Telephone

Operating Instructions

US

*High
Power* **900** MHz

CALLER ID
with call waiting

SPP-S9226

Owner's Record

The model and the serial numbers are located at the bottom of the unit. Record the serial number in the space provided below. Refer to these numbers whenever you call upon your Sony dealer regarding this product.

Model No. SPP-S9226

Serial No. _____

IMPORTANT SAFETY INSTRUCTIONS

When using your telephone equipment, basic safety precautions should always be followed to reduce the risk of fire, electric shock and injury to persons, including the following:

1. Read and understand all instructions.
2. Follow all warnings and instructions marked on the product.
3. Unplug this product from the wall outlet before cleaning. Do not use liquid cleaners or aerosol cleaners. Use a damp cloth for cleaning.
4. Do not use this product near water, for example, near a bath tub, wash bowl, kitchen sink, or laundry tub, in a wet basement, or near a swimming pool.
5. Do not place this product on an unstable cart, stand, or table. The product may fall, causing serious damage to the product.
6. Slots and openings in the cabinet and the back or bottom are provided for ventilation. To protect it from overheating, these openings must not be blocked or covered. The openings should never be blocked by placing the product on the bed, sofa, rug, or other similar surface. This product should never be placed near or over a radiator or heat register. This product should not be placed in a built-in installation unless proper ventilation is provided.
7. This product should be operated only from the type of power source indicated on the marking label. If you are not sure of the type of power supply to your home, consult your dealer or local power company.
8. Do not allow anything to rest on the power cord. Do not locate this product where the cord will be abused by persons walking on it.
9. Do not overload wall outlets and extension cords as this can result in the risk of fire or electric shock.
10. Never push objects of any kind into this product through cabinet slots as they may touch dangerous voltage points or short out parts that could result in a risk of fire or electric shock. Never spill liquid of any kind on the product.
11. To reduce the risk of electric shock, do not disassemble this product, but take it to a qualified service personnel when some service or repair work is required. Opening or removing covers may expose you to dangerous voltages or other risks. Incorrect reassembly can cause electric shock when the appliance is subsequently used.
12. Unplug this product from the wall outlet and refer servicing to qualified service personnel under the following conditions:
 - A. When the power cord or plug is damaged or frayed.
 - B. If liquid has been spilled into the product.
 - C. If the product has been exposed to rain or water.
 - D. If the product does not operate normally by following the operating instructions. Adjust only those controls that are covered by the operating instructions because improper adjustment of other controls may result in damage and will often require extensive work by a qualified technician to restore the product to normal operation.
 - E. If the product has been dropped or the cabinet has been damaged.
 - F. If the product exhibits a distinct change in performance.

13. Avoid using a telephone (other than a cordless type) during an electrical storm. There may be a remote risk of electric shock from lightning.
14. Do not use the telephone to report a gas leak in the vicinity of the leak.

SAVE THESE INSTRUCTIONS

CAUTION:

To reduce the risk of fire or injury to persons by battery, read and follow these instructions.

1. Use only the following type and size battery pack: Sony BP-T24.
2. Do not dispose of the battery pack in a fire. The cell may explode. Check with local codes for possible special disposal instructions.
3. Do not open or mutilate the battery pack. Released electrolyte is corrosive and may cause damage to the eyes or skin. It may be toxic if swallowed.
4. Exercise care in handling battery pack in order not to short the battery with conducting materials such as rings, bracelets, and keys. The battery or conductor may overheat and cause burns.
5. Charge the battery pack provided with or identified for use with this product only in accordance with the instructions and limitations specified in the instruction manual provided for this product.
6. Observe proper polarity orientation between the battery pack and battery charger.

INFORMATION FOR GENERAL TELEPHONES

1. This equipment complies with Part 68 of the FCC rules. On the bottom of this equipment is a label that contains, among other information, the FCC certification number and ringer equivalence number (REN) for this equipment. If requested, this information must be provided to the telephone company.
2. The applicable certification jack (connector) USOC-RJ11C is used for this equipment.

3. This equipment is designed to be connected to the telephone network or premises wiring using a compatible modular jack that is Part 68 compliant.

The FCC compliant telephone cord and modular plug is provided with this equipment.

4. The REN is used to determine the quantity of devices that may be connected to the telephone line. Excessive RENs on the telephone line may result in the devices not ringing in response to an incoming call. Typically, the sum of the RENs should not exceed five (5.0). To be certain of the number of devices that may be connected to a line, as determined by the total RENs, contact the local telephone company.
5. If this equipment (SPP-S9226) causes harm to the telephone network, the telephone company will notify you in advance that temporary discontinuance of service may be required. But if advance notice isn't practical, the telephone company will notify the customer as soon as possible. Also, you will be advised of your right to file a complaint with the FCC if you believe it is necessary.
6. The telephone company may make changes in its facilities, equipment, operations or procedures that could affect the operation of the equipment. If this happens the telephone company will provide advance notice so you can make necessary modifications to maintain uninterrupted service.
7. If trouble is experienced with this equipment (SPP-S9226), for repair or warranty information, please contact Sony Direct Response Center: Tel 1-800-222-7669. If the equipment is causing harm to the telephone network, the telephone company may request that you disconnect the equipment until the problem is resolved.
8. All repairs will be performed in an authorized Sony service station.
9. This equipment cannot be used to party lines or coin lines.
10. This equipment is hearing aid compatible.

If your telephone is equipped with automatic dialers

When programming emergency numbers and (or) making test calls to emergency numbers:

1. Remain on the line and briefly explain to the dispatcher the reason for the call.
2. Perform such activities in the off-peak hours, such as early morning or late evenings.

Caution

You are cautioned that any changes or modifications not expressly approved in this manual could void your authority to operate this equipment.

Note

This equipment has been tested and found to comply with the limits for a Class B digital device, pursuant to Part 15 of the FCC Rules. These limits are designed to provide reasonable protection against harmful interference in a residential installation. This equipment generates, uses and can radiate radio frequency energy and, if not installed and used in accordance with the instructions, may cause harmful interference to radio communications. However, there is no guarantee that interference will not occur in a particular installation. If this equipment does cause harmful interference to radio or television reception, which can be determined by turning the equipment off and on, the user is encouraged to try to correct the interference by one or more of the following measures:

- Reorient or relocate the receiving antenna.
- Increase the separation between the equipment and receiver.
- Connect the equipment into an outlet on a circuit different from that to which the receiver is connected.
- Consult the dealer or an experienced radio/TV technician for help.

Table of contents

Getting Started

- 8 Read this first
 - 9 Step 1: Checking the package contents
 - 10 Step 2: Setting up the base phone
 - 13 Step 3: Preparing the battery pack
 - 15 Step 4: Entering the area code
 - 19 Step 5: Setting up the phone services
 - 24 Step 6: Setting the day and time
 - 26 Identifying the parts
-

Basics

- 30 Making calls
 - 35 Redialing
 - 37 Receiving calls
-

Telephone Features

- 41 One-touch dialing
 - 41 Storing phone numbers and names
 - 43 Changing a stored name and/or phone number
 - 44 Making calls with one-touch dialing
- 45 Phone Directory
 - 45 Storing phone numbers and names
 - 46 Changing a stored name and/or phone number
 - 47 Erasing a memory location

- 48 Making calls from the Phone Directory
- 50 Transferring the Phone Directory memory
- 52 Switching the phones during a call
 - 52 To switch from the base phone to the cordless handset
 - 52 To switch from the cordless handset to the base phone
- 53 Talking between the phones (Intercom)
 - 53 To talk from the cordless handset to the base phone
 - 54 To talk from the base phone to the cordless handset
- 55 Transferring a call
 - 55 To transfer from the base phone to the cordless handset
 - 56 To transfer from the cordless handset to the base phone

Caller ID Features

- 57 Understanding the Caller ID service
 - 57 When you receive a call
- 58 Looking at the Caller ID list
 - 58 Viewing the Caller ID list
 - 59 Erasing data from the Caller ID list
- 61 Using the Caller ID list
 - 61 Calling back a number from the Caller ID list

-
- 63 Storing a number of the Caller ID list into the Phone Directory
 - 64 To change the number of digits of the phone number
 - 66 Using “Caller ID with call waiting” service
 - 67 Using voice mail service

Additional Information

- 69 Mounting the base phone on a wall
- 70 Carrying the cordless handset by the belt clip
- 72 Notes on power sources
- 73 Maintenance
- 74 Troubleshooting
- 78 Specifications
- 79 Index

Back cover LIMITED WARRANTY

Read this first

Before you use your phone, you must first set it up. Here's a quick way to set up your phone: Steps 1 to 6.

Step 1 (page 9)

First, unpack the phone and the supplied accessories.



Base phone



Cordless handset

Step 2 (pages 10 to 12)

You need to do three things to set up the base phone, including finding the best location for the base phone.

Step 3 (pages 13 to 14)

Insert the battery pack into the cordless handset and charge it for more than 12 hours.

Step 4 (pages 15 to 18)

Enter the area code to use the Caller ID service.

Step 5 (pages 19 to 23)

Set up the “Caller ID with call waiting” service, the Long Distance Saver function and the voice mail service.

Step 6 (pages 24 to 25)

Finally, set the day and time.

That's it!

Step 1

Checking the package contents

Make sure you have received the following items in the package.
If anything is missing, contact your local Sony dealer.

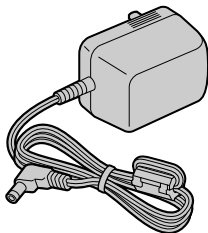

AC power adaptor (AC-T107)



Base phone



Cordless handset

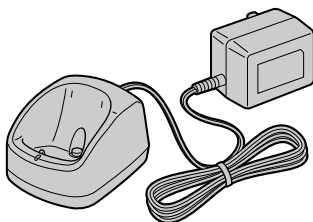

Charger

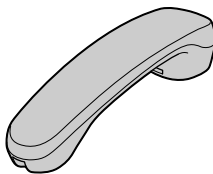

Handset

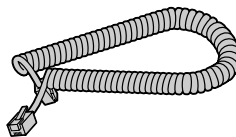

Handset cord

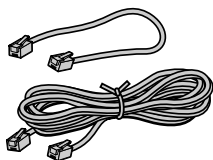

Telephone line cords (2)

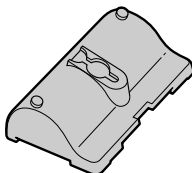

Wall bracket/
stand for base
phone

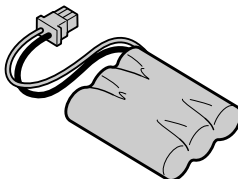

Rechargeable
battery pack
(BP-T24)

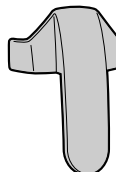

Belt clip

Step 2

Setting up the base phone

Do the following steps:

- Choose the best location
- Connect the base phone
- Choose the dialing mode

Choose the best location

Where you place the base phone affects the reception quality of the cordless handset.

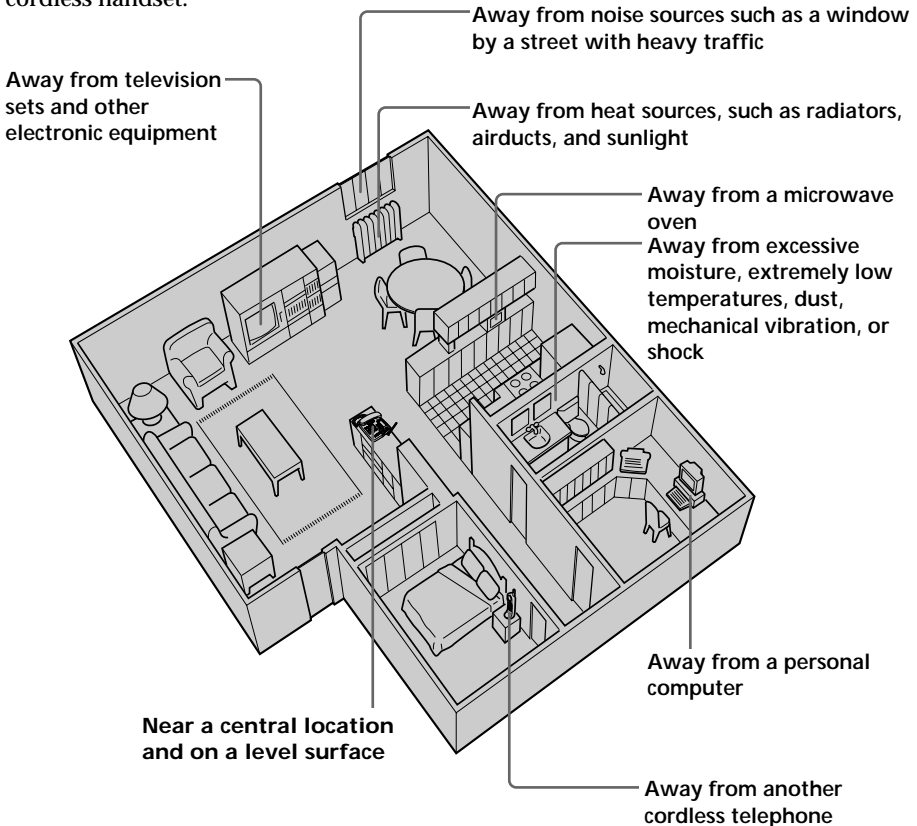

CAUTION:

- Should you experience intermittent loss of audio during a conversation, try moving closer to the base or move base phone away from other noise sources.
- The cordless telephone operates at a frequency that may cause interference to nearby TVs and VCRs; the base phone should not be placed near or on the top of a TV or VCR; and, if interference is experienced, moving the cordless telephone farther away from the TV or VCR will often reduce or eliminate the interference.

Connect the base phone

If you want to hang the base phone on the wall, see page 69.

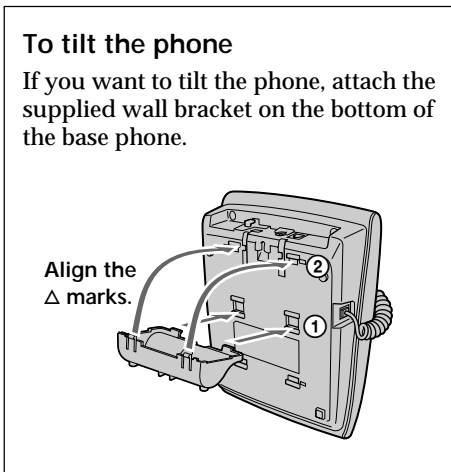
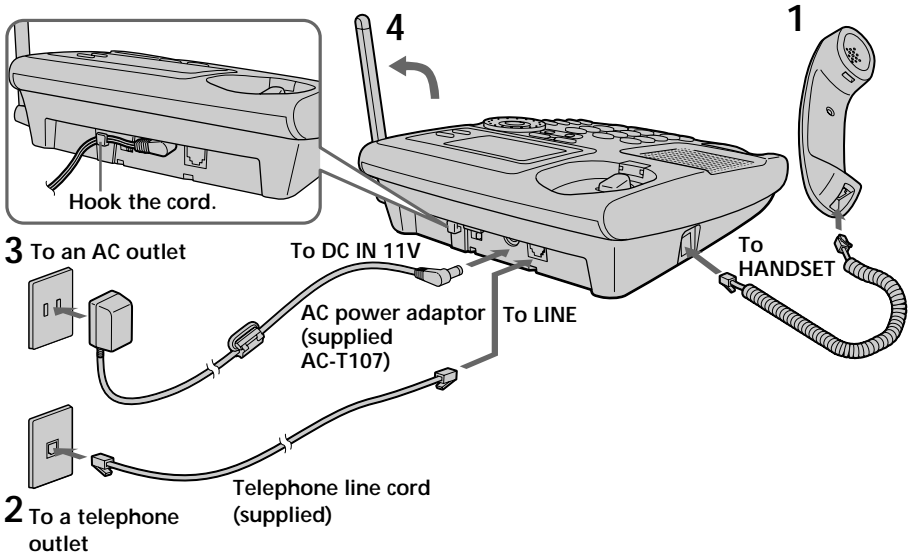

- 1** Connect the handset cord to the HANDSET jack and to the handset.
- 2** Connect the telephone line cord to the LINE jack and to a telephone outlet.
- 3** Connect the AC power adaptor to the DC IN 11V jack and to an AC outlet.
- 4** Raise the antenna. Make sure it points towards the ceiling.

continued

Step 2: Setting up the base phone (continued)

Notes

- Use only the supplied AC-T107 AC power adaptor. Do not use any other AC power adaptor.
- Connect the AC power adaptor to a continuous power supply.
- Place the base phone close to the AC outlet so that you can unplug the AC power adaptor easily.

Polarity of the plug

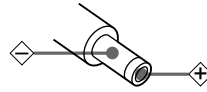

Tip

If your telephone outlet is not modular, contact your telephone service company for assistance.

Modular



Choose the dialing mode

For the telephone to work properly, select an appropriate dialing mode (tone or pulse).

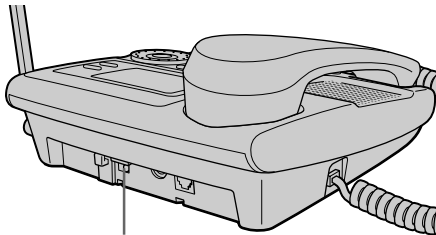

DIAL MODE switch

Depending on your dialing system, set the DIAL MODE switch as follows:

| If your dialing system is | Set the switch to |
|---------------------------|-------------------|
| Tone | T |
| Pulse | P |

If you aren't sure of your dialing system

Make a trial call with the DIAL MODE switch set to T. If the call connects, leave the switch as is; otherwise, set to P.

Step 3

Preparing the battery pack

Charge the battery pack for more than 12 hours before you start using your cordless handset.

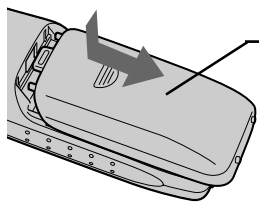
- 

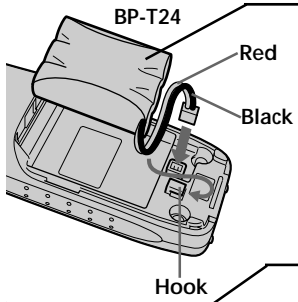
1 Slide open the battery compartment lid of the cordless handset.
- 

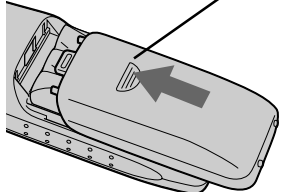
2 Connect the battery connector with correct polarity (black wire goes on lower side and red wire goes on upper side).
- 

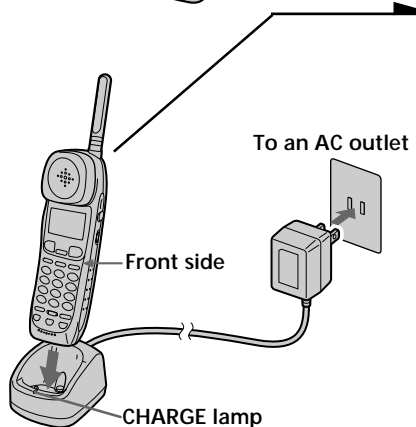
3 Hook the cords and insert the battery pack. Then close the lid.
- 

4 Connect the AC power adaptor to an AC outlet and place the cordless handset on the charger. The CHARGE lamp on the charger lights up when the cordless handset is properly seated on the charge terminals of the charger. Charge the battery pack for more than 12 hours so that the battery is fully charged. The CHARGE lamp remains lit even after charging is completed.

continued

Step 3: Preparing the battery pack (continued)

Battery duration

A fully charged battery pack lasts for about:

- Approx. 5 hours when you use the cordless handset continuously
- Approx. 6 days when the cordless handset is in standby mode.

Notes

- The battery pack will gradually discharge over a long period of time, even when not in use.
- If you leave the battery pack in the cordless handset without charging it, the battery pack will be completely discharged.
It may require several times of charging to recover to its full capacity.
- While charging, the battery pack warms up. This is not a malfunction.

To obtain the best performance from the battery

Do not place the cordless handset on the charger after each call. The battery works best if the cordless handset is returned to the charger after two or three calls. However, do not leave the cordless handset off the charger for a long period of time as this will completely discharge the battery pack.

When to purchase a new battery pack

If the battery lasts only a few minutes even after **12 hours** of charging, the usable life of the battery has expired and needs replacement. Contact your local Sony authorized dealer or service center, and ask for a Sony **BP-T24** rechargeable battery pack.

Note

Battery life may vary depending on usage condition and ambient temperature.

Step 4

Entering the area code

When you use this phone for the first time, or move to an area that has a different area code, you must enter the area code. Otherwise, you cannot use some functions of this phone and the Caller ID functions.

This is also necessary because the phone must be able to select an area code to properly dial a call from the Caller ID list.

Depending on your region, enter the 3-digit area code as follows:

Case 1.

If 7-digit dialing (no area code) is accepted for local calls in your area, see “To enter your home area code” below.

If you live in an area where calls from or to other local areas can also be made by 10-digit dialing (area code + number), you can register up to 5 local area codes with this telephone to take advantage of this system. See “To enter the local area code (For 10 digits phone number users)” on page 17.

Case 2.

If 10-digit dialing (area code + number) is required for all local calls in your area, see “To enter the local area code (For 10 digits phone number users)” on page 17.

Entering the area code is only possible on the base phone.

To enter your home area code

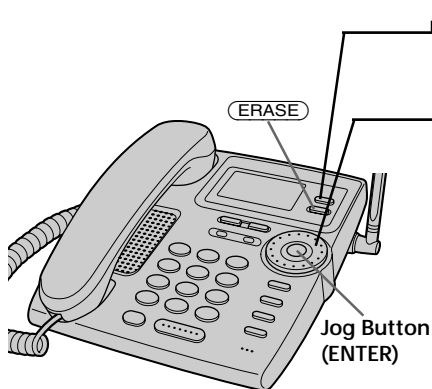

1 Press **PROGRAM**.

2 Turn Jog Dial to choose “BASE SETTINGS”, and then press Jog Button (ENTER).

```

BASE SETTINGS
【GO BACK】
▶ AREA CODE
PHONE SERVICES
↓ MESSAGES LAMP
  
```

3 Press Jog Button (ENTER).

```

AREA CODE
【GO BACK】
▶ HOME :
LOCAL 1:
↓ LOCAL 2:
  
```

continued

Step 4: Entering the area code (continued)

4 Press Jog Button (ENTER) again.
“ENTER HOME AREA CODE.” appears on the display.

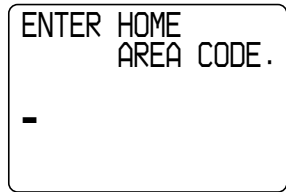

5 Enter the three digits of your home area code using the dialing keys.

6 Press (PROGRAM).

You hear a long confirmation beep.

Notes

- If the home area code is already entered, it appears on the display in step 3. To enter a different home area code, see “To change the home area code” below.
- Do not allow more than 20 seconds to elapse during the operation procedure.
- If the area code has not been entered, calling back from the Caller ID list and storing the Caller ID data into the Phone Directory cannot be performed.
- If the home area code is not correctly entered, “SEND TO CORDLESS HANDSET FAILED.” will appear on the display and five short error beeps will be heard after (PROGRAM) is pressed in step 6. Move the cordless handset closer to the base phone, and then start over the procedure.

Tips

- When you select “[GO BACK]”, you can return to the previous set display by pressing Jog Button (ENTER).
- You may press Jog Button (ENTER) instead of (PROGRAM) in step 6.
- To check the current home area code, perform steps 1 to 3. The home area code appears on the display for about 20 seconds.

To change the home area code

1 Perform steps 1 to 4 on pages 15 to 16.

The current home area code appears on the display.

2 Press (ERASE) to erase the current home area code.

3 Enter a new home area code using the dialing keys.

4 Press (PROGRAM).

You hear a long confirmation beep.

To erase the home area code

You can erase the home area code. Perform steps 1 and 2 above, then press (PROGRAM).

The home area code will be erased, and you hear a long confirmation beep.

To enter the local area code (For 10 digits phone numbers users)

If a call matches one of the local area codes you entered, the phone number will be registered with 10 digits in the Caller ID list (area code + number). If a call does not match one of the local area codes you entered, the phone number will be registered with 11 digits in the Caller ID list (1 + area code + number). Some regions of the country allow you to have more than one local area code. (Up to five local area codes can be entered in this phone.)

- 1 Perform steps 1 to 3 on page 15.
- 2 Select the number (“LOCAL 1” to “LOCAL 5”) to enter the local area code by turning Jog Dial.

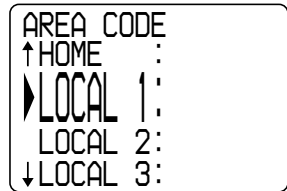

- 3 Press Jog Button (ENTER).

“ENTER LOCAL AREA CODE 1.” appears on the display when you select “LOCAL 1” in step 2.

- 4 Enter the three digits of the local area code using the dialing keys.
- 5 Press **(PROGRAM)**.

You hear a long confirmation beep.

Notes

- If the local area code is already entered, it appears on the display in step 2. To enter a different local area code, see “To change the local area code” on page 18.
- Do not allow more than 20 seconds to elapse during the operation procedure.
- If the local area code is not correctly entered, “SEND TO CORDLESS HANDSET FAILED.” will appear on the display and five short error beeps will be heard after **(PROGRAM)** is pressed in step 5. Move the cordless handset closer to the base phone, and then start over the procedure.

Tips

- When you select “[GO BACK]”, you can return to the previous set display by pressing Jog Button (ENTER).
- You may press Jog Button (ENTER) instead of **(PROGRAM)** in step 5.
- To check the current local area code, perform steps 1 and 2. The local area code appears on the display for about 20 seconds.

continued

Step 4: Entering the area code (continued)

To change the local area code

1 Perform steps 1 to 3 on page 17.

The current local area code appears on the display.

2 Press **ERASE** to erase the current local area code.

3 Enter a new local area code using the dialing keys.

4 Press **PROGRAM**.

You hear a long confirmation beep.

To erase the local area code

You can erase the local area code. Perform steps 1 and 2 on page 17, then press **PROGRAM**. The local area code will be erased, and you hear a long confirmation beep.

Step 5

Setting up the phone services

Set up the “Caller ID with call waiting” service, the Long Distance Saver function and the voice mail service before use. Setting up the phone services is only possible on the base phone.

To set up the “Caller ID with call waiting” service

In order to use this service, you must first subscribe to “Caller ID with call waiting” service (see page 66). The “Caller ID with call waiting” service is preset to “ACTIVE”.

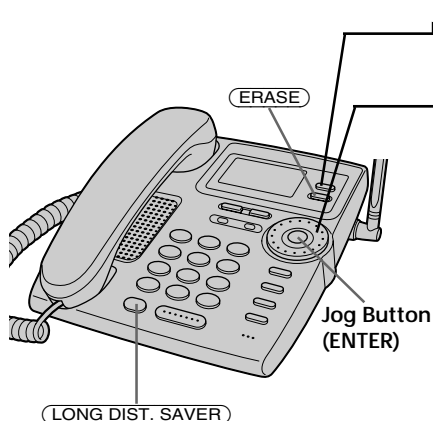

- 1 Press **PROGRAM**.
- 2 Turn Jog Dial to choose “BASE SETTINGS”, and then press Jog Button (ENTER).
- 3 Turn Jog Dial to choose “PHONE SERVICES”, and then press Jog Button (ENTER).

```
PHONE SERVICES
【GO BACK】
▶CALL WAITING ID
VOICE MAIL
LONG DISTANCE
```

- 4 Press Jog Button (ENTER).

```
CALL WAITING ID
【GO BACK】
▶ACTIVE
INACTIVE
```

- 5 Turn Jog Dial to choose “ACTIVE” or “INACTIVE”, and then press Jog Button (ENTER). You hear a long confirmation beep.

continued

Step 5: Setting up the phone services (continued)

Note

Do not allow more than 20 seconds to elapse during the operation procedure.

Tip

When you select “[GO BACK]”, you can return to the previous set display by pressing Jog Button (ENTER).

To set up the Long Distance Saver function

Many telephone companies and service providers nowadays offer low-rate long distance calls separate from your standard long distance provider. Such services are usually initiated by dialing an access number prior to the long distance call itself.

The Long Distance Saver function enables you to dial the access number of these special long distance service companies by pressing just **(LONG DIST. SAVER)**. After setting up the access number and activating the button function in the menu, you only need to press **(LONG DIST. SAVER)** for dialing the access number of your special long distance carrier.

In order to use this function, you must first activate the button function by memorizing the access number of your choice in the menu and by setting the long distance menu function to “ACTIVE”

The long distance menu is preset to “INACTIVE”, no preset access number is registered.

To set up the access number

- 1 Perform steps 1 and 3 on page 19.
- 2 Turn Jog Dial to choose “LONG DISTANCE”, and then press Jog Button (ENTER).
- 3 Turn Jog Dial to choose “ACCESS NUMBER”, and then press Jog Button (ENTER).
- 4 Enter the access number using the dialing keys.
- 5 Press **(PROGRAM)**.
- 6 Turn Jog Dial to choose “YES” to activate **(LONG DIST. SAVER)**, and then press Jog Button (ENTER).

You hear a long confirmation beep.

continued

Step 5: Setting up the phone services (continued)

Notes

- DO NOT USE **(LONG DIST. SAVER)** to dial EMERGENCY services, customer service numbers, your local telephone company, local numbers or toll free numbers.
- If you press **(LONG DIST. SAVER)** twice, the dialing of the registered access number is cancelled and “[LONG DISTANCE]” disappears from the display.
- If the access number is not correctly set, “SEND TO CORDLESS HANDSET FAILED.” will appear on the display and five short error beeps will be heard after Jog Button (ENTER) is pressed in step 6. Move the cordless handset closer to the base phone, and then start over the procedure.
- You can register up to 24 digits as an access number.

To change the access number

- 1 Perform steps 1 and 3 on page 21.

The current access number appears on the display.

- 2 Press **(ERASE)** to erase the current access number.
- 3 Enter a new access number using the dialing keys.
- 4 Press **(PROGRAM)**.
- 5 Turn Jog Dial to choose “YES” to activate **(LONG DIST. SAVER)**, and then press Jog Button (ENTER).

You hear a long confirmation beep.

To activate/deactivate the Long Distance Saver function

- 1 Perform steps 1 to 3 on page 19.
- 2 Turn Jog Dial to choose “LONG DISTANCE”, and then press Jog Button (ENTER).
- 3 Turn Jog Dial to choose “ACTIVE” or “INACTIVE” (to deactivate), and then press Jog Button (ENTER).

You hear a long confirmation beep.

Notes

- If you choose “INACTIVE” in step 3, **(LONG DIST. SAVER)** will be deactivated and you cannot use **(LONG DIST. SAVER)** even with a registered access number until the function is activated again.
- Some Long Distance services may not be available in your state. Prices and conditions may vary. For details, contact your telephone company or your long distance provider. Some long distance call programs require a subscription with the carrier company before usage.
- If it is not correctly set in “ACTIVE” or “INACTIVE”, “SEND TO CORDLESS HANDSET FAILED.” will appear on the display and five short error beeps will be heard after Jog Button (ENTER) is pressed in step 3. Move the cordless handset closer to the base phone, and then start over the procedure.

To set up the voice mail service

In order to use this service, you must first subscribe to voice mail service (see page 67). The voice mail service is preset to “ACTIVE”.

- 1 Perform steps 1 to 3 on page 19.
- 2 Turn Jog Dial to choose “VOICE MAIL”, and then press Jog Button (ENTER).
- 3 Turn Jog Dial to choose “ACTIVE” or “INACTIVE”, and then press Jog Button (ENTER).

You hear a long confirmation beep.

Step 6

Setting the day and time

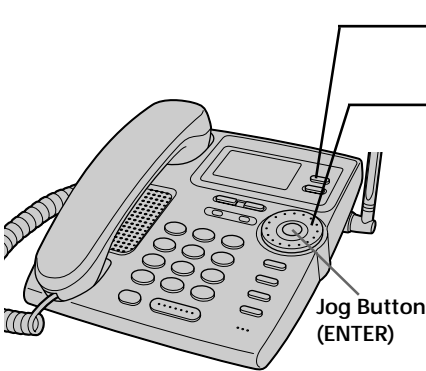

- 1 Press **PROGRAM**.
- 2 Turn Jog Dial to choose “BASE SETTINGS”, and then press Jog Button (ENTER).
- 3 Turn Jog Dial to choose “CLOCK”, and then press Jog Button (ENTER).



- 4 Set the correct day of the week by turning Jog Dial, and then press Jog Button (ENTER).



- 5** Set the hour (1 to 12) by turning Jog Dial, and then press Jog Button (ENTER).

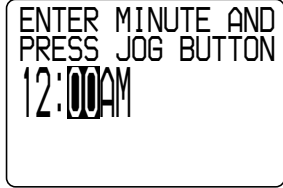

- 6** Set the minute (00 to 59) by turning Jog Dial, and then press Jog Button (ENTER).

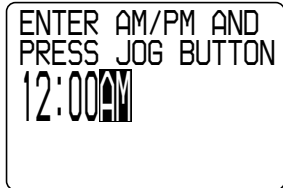

- 7** Choose “AM” or “PM” by turning Jog Dial, and then press Jog Button (ENTER).

You hear a long confirmation beep. Then the phone starts counting time.

Notes

- Do not allow more than 60 seconds to elapse during the operation procedure.
- “SUN 12:00AM” on the display of the base phone flashes when the day and time is cleared due to a power interruption, or when you connect the base phone to the AC outlet for the first time.

Tip

When you select “[GO BACK]”, you can return to the previous set display by pressing Jog Button (ENTER).

Identifying the parts

Refer to the pages indicated in parentheses for details.

Base phone

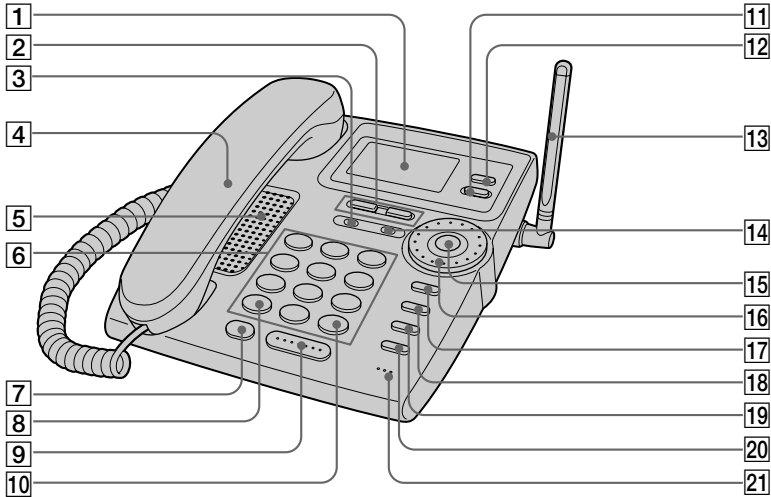

1 Display window (p. 33, 57)

2 VOLUME +/- buttons
(p. 34)

Adjusts the handset or speaker volume.

3 NEW CALL lamp (p. 58)

Flashes when there is a “NEW” data in the Caller ID list.

4 Handset (p. 11, 33, 39)

5 Speaker

6 Dialing keys (p. 33)

7 LONG DIST. SAVER button
(p. 21, 33)

Lets you make a long distance call with the registered access number.

8 * TONE button (p. 34)

Allows you to switch temporarily to tone dialing.

9 SPEAKERPHONE button
(p. 33)

Lets you make or receive a call.

10 # button (p. 64)

Used to change the number of digits of the phone number in the Caller ID list.

11 ERASE button (p. 16, 22)

12 PROGRAM button (p. 15)

13 Antenna (p. 11, 69)

14 MESSAGES lamp (p. 67)

Flashes when you have messages.

15 Jog Button (ENTER) (p. 15)

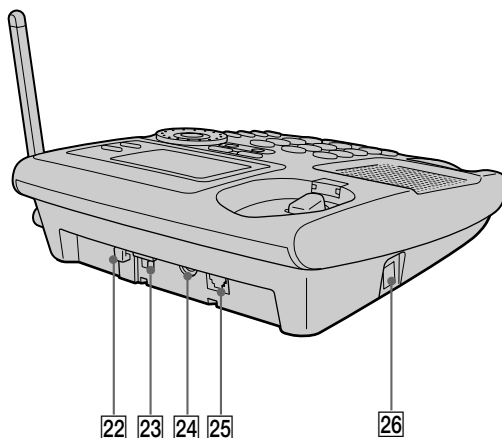

- 16** Jog Dial (p. 15, 58)
- 17** REDIAL/PAUSE button (p. 35)
Redials one of the last five numbers called/inserts a pause in the dialing sequence.
- 18** INTERCOM button (p. 54)
Lets you talk between the base phone and cordless handset.
- 19** CALL WAITING/FLASH button (p. 34, 66)
Switches to a second call if you have “call waiting” service, or lets you make a new call.
- 20** HOLD button (p. 34)
Puts a call on hold.
- 21** MIC (microphone)
- 22** Hook for AC power adaptor cord (p. 11, 69)
- 23** DIAL MODE switch (p. 12)
Selects pulse or tone dialing.
- 24** DC IN 11V jack (p. 11, 69)
- 25** LINE (telephone line) jack (p. 11, 69)
- 26** HANDSET jack (p. 11)

continued

Identifying the parts (continued)

Cordless handset

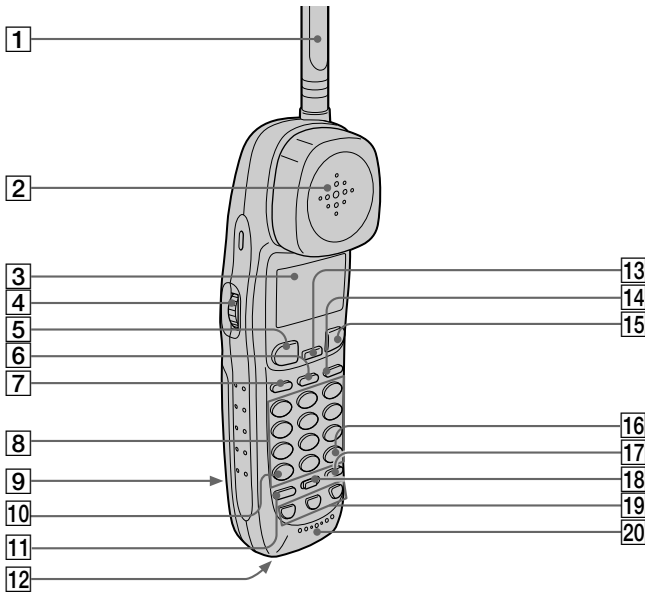

- | | |
|---|---|
| 1 Antenna | 10 ✖ TONE button (p. 31) Allows you to switch temporarily to tone dialing. |
| 2 Speaker [EZfit] (p. 32) | 11 HOLD button (p. 31) Puts a call on hold. |
| 3 Display window (p. 30, 57) | 12 RING switch (p. 38) Switches the ringer to on/off. |
| 4 Jog Dial (p. 41, 58) | 13 CALL WAITING/FLASH button (p. 31, 66) Switches to a second call if you have “call waiting” service, or lets you make a new call. |
| 5 TALK button (p. 30) Lets you make or receive a call. | 14 REDIAL/PAUSE button (p. 35, 43) Redials one of the last five numbers called/inserts a pause in the dialing sequence. |
| 6 INTERCOM button (p. 53) Lets you talk between the base phone and the cordless handset. | |
| 7 LONG DIST. SAVER button (p. 21, 31) Lets you make a long distance call with the registered access number. | |
| 8 Dialing keys (p. 30) | |
| 9 Battery compartment (p. 13) | |

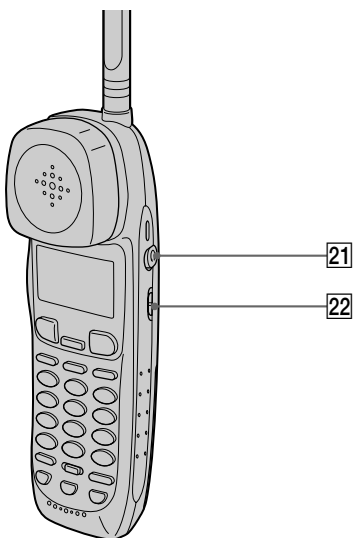

- 15 OFF button** (p. 30)
Allows you to disconnect the call.
- 16 # button** (p. 64)
Used to change the number of digits of the phone number in the Caller ID list.
- 17 PROGRAM button** (p. 41)
- 18 ERASE button** (p. 43)
- 19 ONE-TOUCH DIAL (A, B, C) buttons** (p. 44)
- 20 Microphone**
- 21**  (HEADSET) jack (p. 30, 37, 71)
- 22 VOL (volume) switch** (p. 31)
Adjust the cordless handset volume.

Making calls

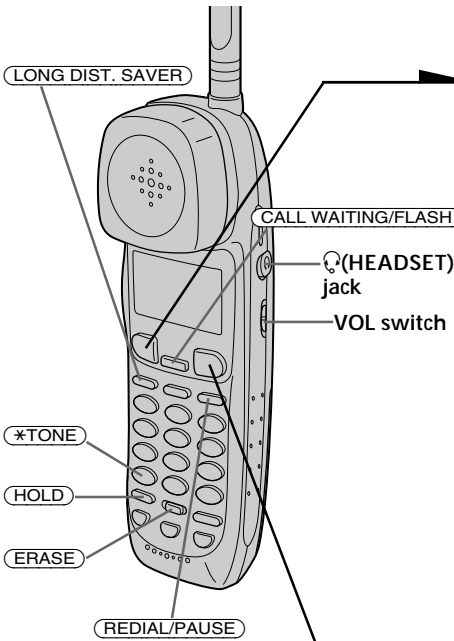

- 1** Pick up the cordless handset from the charger.
- 2** Press **TALK** and wait until “TALK” appears on the display and the display also shows the talk time in hours, minutes and seconds.

The dialing keys light up. You then hear a dial tone. “CORDLESS HANDSET IN USE” appears on the display of the base phone.

If you hear five short error beeps and “OUT OF RANGE” appears on the display, move closer to the base phone.
- 3** Dial the phone number.
- 4** When you’re done talking, press **OFF** or replace the cordless handset on the charger.

The display turns off.

To make a call after checking the phone number

You can dial the phone number before pressing **TALK** or **LONG DIST. SAVER**. If you make a mistake when dialing the phone number, press **ERASE** to erase the number.

Making calls when the headset is connected

When a headset (optional) is connected to the  (HEADSET) jack on the cordless handset, you can talk through the headset.

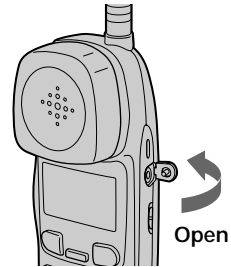

Making calls using the Long Distance Saver function

Set the menu for the Long Distance Saver function to “ACTIVE”. See “To set up the Long Distance Saver function” on page 22.

- 1 Pick up the cordless handset from the charger.
- 2 Press **(LONG DIST. SAVER)**.
 “[LONG DISTANCE]” appears on the display.
 To cancel this function, press **(LONG DIST. SAVER)** again or press **(TALK)**.
- 3 Dial the long distance phone number (e.g., 1-201-123-4567, or 011-...).
- 4 When you’re done talking, press **(OFF)** or replace the cordless handset on the charger.

To make a call via Private Branch Exchange (PBX)

Before pressing **(LONG DIST. SAVER)** in step 2 above, enter the outside line access digit (e.g., 9).



Additional tasks

| To | Do this |
|--|--|
| Adjust the cordless handset volume | Set the VOL switch to H (high), M (middle) or L (low). |
| Put a call on hold | Press (HOLD) . “HOLD” appears on the display. Press (HOLD) again or pick up the cordless handset from the charger (When Quick talk is set to “USE”; see page 38) to resume the conversation. |
| Switch to tone dialing temporarily | Press (*TONE) after you’re connected. The line will remain in tone dialing until disconnected. |
| Switch to another call (“call waiting” service*) | Press (CALL WAITING/FLASH) . Press (CALL WAITING/FLASH) again to return to the first caller. |

* You need to subscribe to this service from your telephone company.

Making calls (continued)

Notes

- When making a call on the cordless handset, “” appears on the display indicating the receiver sensitivity with the base phone. Three bars indicate a good reception, no bar indicates a bad reception. When calling from an area with poor reception, you may experience interference or the call may be disconnected, so try to use the cordless handset in areas that have a good reception.
- When you increase the sound volume, in some cases the back ground noise may be increased as well. You should adjust the volume accordingly.
- If the cordless handset beeps every second during a conversation and “” appears on the display, move closer to the base phone; otherwise, you will hear five short error beeps and “OUT OF RANGE” will appear on the display, and the call will be disconnected after 30 seconds.
- While talking with an outside caller via the base phone, you cannot make a call with the cordless handset. If you press **(TALK)**, “BASEPHONE IN USE” appears on the display and you will hear a busy tone.
- When the talk time exceeds 9:59:59, the display counts from 0:00:00 again.

EZfit

The “EZfit” adjusts to fit any shape ear, thereby ensuring clear voice reception.

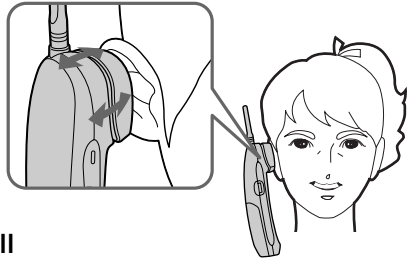

If the battery becomes weak during a call

The cordless handset will beep twice per second, “BATTERY LOW” appears on the display. Finish your call and replace the cordless handset on the charger to charge the battery pack. Or, to continue your phone conversation with the base phone, press **(HOLD)** on the cordless handset to hold the line, and then pick up the handset or press **(SPEAKERPHONE)** on the base phone.

For optimum performance, charge the battery for a full 12 hours.

Note that during the initial charge time (approx. 10 minutes), “PLEASE WAIT...” and “BATTERY LOW” appear on the display and the cordless handset cannot be used.

After “BATTERY LOW” turns off, you may be able to use the cordless handset, but the battery duration will be very short; thus it is recommended that you **fully charge** the battery before next use.

Making calls with the base phone

Pick up the handset or press **(SPEAKERPHONE)** on the base phone. “TALK” or “SPEAKERPHONE” appears on the display and the display also shows the talk time in hours, minutes and seconds.

Dial the phone number.

When you’re done talking, replace the handset in the cradle or press **(SPEAKERPHONE)** again.

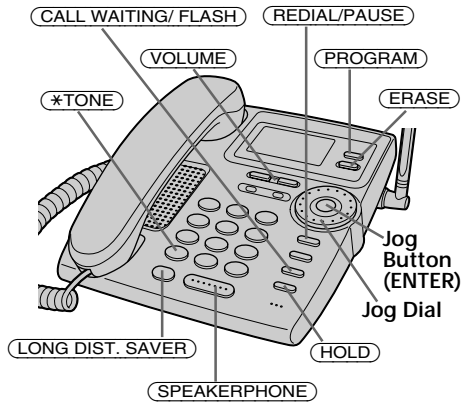

To make a call after checking the phone number

You can dial the phone number before picking up the handset or before pressing **(SPEAKERPHONE)**. If you make a mistake when dialing the phone number, press **(ERASE)** to erase the number.

Making calls using the Long Distance Saver function

Set the menu for the Long Distance Saver function to “ACTIVE”. See “To set up the Long Distance Saver function” on page 22.

- 1 Pick up the handset or press **(SPEAKERPHONE)** on the base phone.
- 2 Press **(LONG DIST. SAVER)**.
“[LONG DISTANCE]” appears on the display.
To cancel this function, press **(LONG DIST. SAVER)** again.
- 3 Dial the long distance phone number (e.g., 1-201-123-4567, or 011-...).
- 4 When you’re done talking, replace the handset in the cradle or press **(SPEAKERPHONE)** again.

To make a call via Private Branch Exchange (PBX)

Before pressing **(LONG DIST. SAVER)** in step 2 above, enter the outside line access digit (e.g., 9).

Making calls (continued)

Additional tasks

| To | Do this |
|--|--|
| Adjust the handset or speakerphone volume | During phone conversation, press (VOLUME) (+) or (-) . There are 3 steps for the handset volume level, and 7 steps for the speakerphone volume level. |
| Put a call on hold | Press (HOLD) . "HOLD" appears on the display. Press (HOLD) , (SPEAKERPHONE) , or pick up the handset from the base phone to resume the conversation. |
| Switch to tone dialing temporarily | Press (*TONE) after you're connected. The line will remain in tone dialing until disconnected. |
| Switch to another call ("call waiting" service*) | Press (CALL WAITING/ FLASH) . Press (CALL WAITING/ FLASH) again to return to the first caller. |

* You need to subscribe to the service from your telephone company.

Notes

- While talking with an outside caller via the cordless handset, the display on the base phone shows "CORDLESS HANDSET IN USE" and you cannot make a call with the base phone.
- When the talk time exceeds 9:59:59, the display counts from 0:00:00 again.

Tip

You can switch between phone conversations via the handset and those via the speakerphone, simply by picking up the handset while talking over the speakerphone, or by pressing **(SPEAKERPHONE)** while talking over the handset.

To obtain the best speakerphone performance

- You may not be able to hear the other party's voice in a noisy place. Therefore, use the speakerphone in a quiet room.
- Do not bring your hand or other object too close to the microphone or you will hear a shrill noise ("feedback").
- When the speaker volume is loud, or the base phone has been placed close to a wall, you may find that the volume drops suddenly. This is due to a circuit in the telephone designed to protect against feedback. In such cases, lower the speaker volume slightly.

Redialing

Both the base phone and the cordless handset can each individually store five dialed phone numbers.

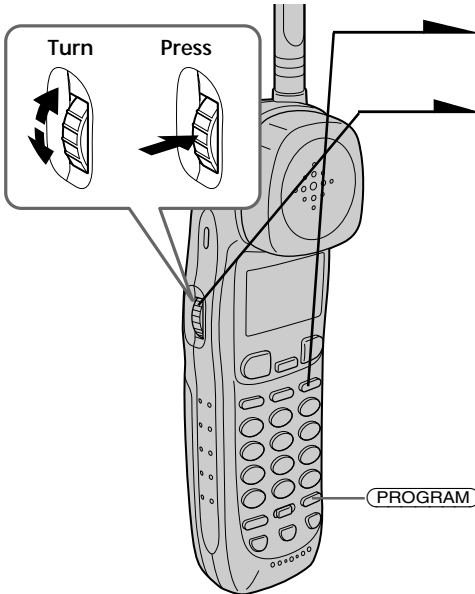

- 1 Press **REDIAL/PAUSE**.
- 2 Display the name or phone number you want to call by turning Jog Dial, and then press Jog Dial. (If you're at the base phone, press Jog Button (ENTER).)
- 3 Turn Jog Dial to choose "DIAL" or "LONG DISTANCE", and then press Jog Dial (or Jog Button (ENTER)).
The phone number will be redialed.

Notes

- When the Long Distance Saver function is set to "ACTIVE", "LONG DISTANCE" call can be made (see page 22).
- The redial memory only registers up to 30 digits. Exceeding numbers will not be redialed.
- In the case of a power failure, only the redial on the base phone will be erased.
- The redial button does not store the access number of the Long Distance Saver. To redial a long distance call, press **LONG DIST. SAVER**, then **REDIAL/PAUSE**.

Tips

- When "→" is displayed on the right end of the phone number on the redial list in step 2, it means that some number follows the displayed phone number. Moreover, when the phone number is selected by turning Jog Dial, all of the phone number is displayed in two lines.
- If you redial the same number repeatedly, this number will only be counted as one number of the total five registered numbers that can be redialed.
- When dialing from a phone number with a registered name, that name will be displayed in the list in step 2.

continued

Making calls (continued)

To store the dialed phone number into the Phone Directory

- 1 Display the name or phone number you want to store by doing steps 1 and 2 on page 35.
- 2 Turn Jog Dial to choose “PROGRAM”, and then press Jog Dial. (If you’re at the base phone, press Jog Button (ENTER).)
- 3 Enter the name by doing steps 4 and 5 on page 42.
- 4 Turn Jog Dial to choose “[PGM]”, and then press Jog Dial (or Jog Button (ENTER)).

You hear a long confirmation beep, and the name and the number are stored.

Note

The dialed phone numbers of up to 20 digits can be stored in the Phone Directory.

To erase the dialed phone number one by one

- 1 Display the name or phone number you want to erase by doing steps 1 and 2 on page 35.
- 2 Turn Jog Dial to choose “ERASE REDIAL”, and then press Jog Dial. (If you’re at the base phone, press Jog Button (ENTER).)
- 3 Turn Jog Dial to choose “YES”, and then press Jog Dial (or Jog Button (ENTER)).

You hear a long confirmation beep, and the number is erased.

To erase the entire dialed phone numbers at once

- 1 Press **PROGRAM**.
- 2 Turn Jog Dial to choose “MEMORY MANAGE”, and then press Jog Dial. (If you’re at the base phone, press Jog Button (ENTER).)
- 3 Turn Jog Dial to choose “ERASE ALL RDL”, and then press Jog Dial (or Jog Button (ENTER)).
- 4 Turn Jog Dial to choose “ERASE REDIAL”, and then press Jog Dial (or Jog Button (ENTER)).

You hear a long confirmation beep, and the entire number are erased.

Receiving calls

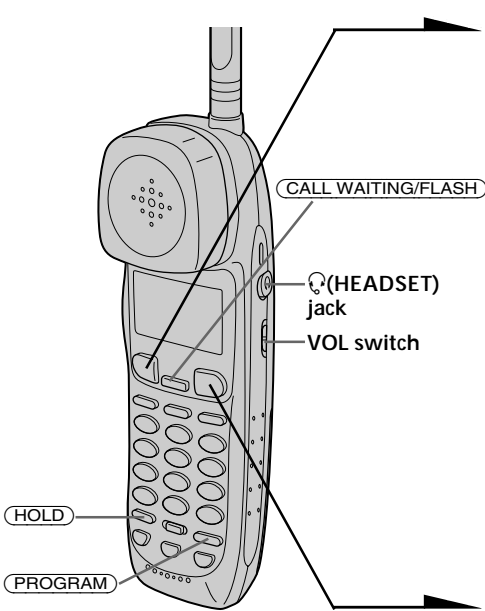

- 1** When you hear the phone ring:
- Press **TALK**.
- or
- Pick up the cordless handset from the charger when the cordless handset is placed on the charger. (When Quick talk is set to “USE”; see page 38)
- “TALK” appears on the display and the display also shows the talk time in hours, minutes and seconds.

“CORDLESS HANDSET IN USE” appears on the display of the base phone.

- 2** When you’re done talking, press **OFF** or replace the cordless handset on the charger. The display turns off.

Receiving calls when the headset is connected

When a headset (optional) is connected to the (HEADSET) jack on the cordless handset, you can talk through the headset.

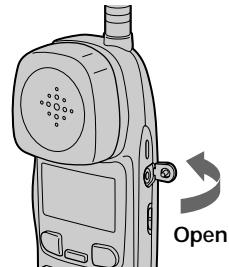

continued

Receiving calls (continued)

Additional tasks

| To | Do this |
|--|--|
| Adjust the cordless handset volume | Set the VOL switch to H (high), M (middle) or L (low). |
| Put a call on hold | Press (HOLD) . "HOLD" appears on the display. Press (HOLD) again or pick up the cordless handset from the charger (When Quick talk is set to "USE"; see below) to resume the conversation. |
| Switch to another call ("call waiting" service*) | Press (CALL WAITING/FLASH) . Press (CALL WAITING/FLASH) again to return to the first caller. |
| Receive a call by only picking up the cordless handset from the charger, without pressing (TALK) (Quick talk) | Press (PROGRAM) . Turn Jog Dial to choose "QUICK TALK", then press Jog Dial. Turn Jog Dial to choose "USE", then press Jog Dial. |

* You need to subscribe to this service from your telephone company.

Note

If there is an incoming call during intercom conversation, intercom call will be disconnected, and both the base phone and the cordless handset will ring.

Tip

To inform you of an incoming call, the display shows "** RINGING **" even when you set the RING switch on the cordless handset to OFF.

If you have subscribed to the Caller ID service;

- the caller's number and/or name appears on the display when you receive a call (see page 57) or when another call comes in by "call waiting" service.
- the name stored in the one-touch dialing or Phone Directory appears on the display if the call matches the number stored on ONE-TOUCH DIAL buttons or in the Phone Directory (memory match function; see page 57).
- the ringer sound changes to a higher tone if the call matches the number VIP stored on ONE-TOUCH DIAL buttons or in the Phone Directory (memory match function; see page 57).

To turn the ringer off

Set the RING switch on the bottom to OFF.

"[RINGER OFF]" appears on the display.

The cordless handset won't ring. You can still make calls, and also receive calls if another telephone connected to the same line rings to inform you on incoming calls. You can also receive an intercom call.

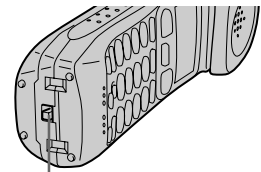

RING switch

Receiving calls with the base phone

When you hear the phone ring, pick up the handset or press **(SPEAKERPHONE)** on the base phone.

“TALK” or “SPEAKERPHONE” appears on the display and the display also shows the talk time in hours, minutes and seconds.

When you’re done talking, replace the handset in the cradle or press **(SPEAKERPHONE)** again.

To obtain the best speakerphone performance, see page 34.

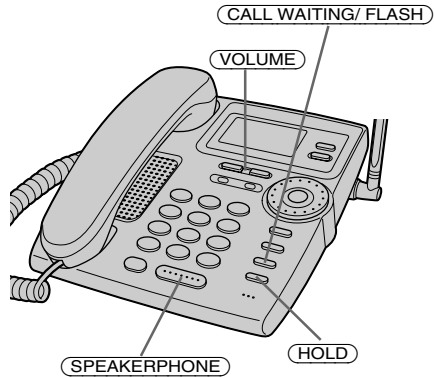

Additional tasks

| To | Do this |
|--|--|
| Adjust the handset or speakerphone volume | During phone conversation, press (VOLUME) (+) or (-) . There are 3 steps for the handset volume level, and 7 steps for the speakerphone volume level. |
| Put a call on hold | Press (HOLD) . “HOLD” appears on the display. Press (HOLD) , (SPEAKERPHONE) , or pick up the handset from the base phone to resume the conversation. |
| Switch to another call (“call waiting” service*) | Press (CALL WAITING/ FLASH) . Press (CALL WAITING/ FLASH) again to return to the first caller. |
| Adjust the ringer volume of the base phone | Press (VOLUME) (+) or (-) . The ringer volume can be adjusted to three different levels: high, low, and “OFF”. If the ringer is set to “OFF”, “[RINGER OFF]” will appear on the display. |

* You need to subscribe to the service from your telephone company.

Receiving calls (continued)

Notes

- Even when you set “RINGER VOL” on the base phone to “OFF”, the cordless handset will ring when the RING switch on the cordless handset is set to ON.
- If there is an incoming call during intercom conversation, intercom call will be disconnected, and both the base phone and the cordless handset will ring.

Tips

- To inform you of an incoming call, the display shows “** RINGING **” even when you set “RINGER VOL” on the base phone to “OFF”.
- You can switch between phone conversations via the handset and those via the speakerphone, simply by picking up the handset while talking over the speakerphone, or by pressing **(SPEAKERPHONE)** while talking over the handset.

One-touch dialing

You can dial with one touch of a key by storing a phone number on a one-touch dialing button.

Storing phone numbers and names

Example: to store “SONY” “123-4567”.

The diagram illustrates the process of storing a phone number and name on a mobile phone. It shows a side view of the phone with callouts for various buttons: TALK, REDIAL/PAUSE, LONG DIST. SAVER, ERASE, and ONE-TOUCH DIAL buttons. A callout box shows the 'Turn' and 'Press' actions for the one-touch dial buttons. Three numbered steps are provided, each with a corresponding screen display:

- 1** Press **PROGRAM**.
The screen displays:
HANDSET MENU
[GO BACK]
▶ PHONE DIRECTORY
ONE-TOUCH DIAL
↓ QUICK TALK
- 2** Turn Jog Dial to choose “ONE-TOUCH DIAL”, and then press Jog Dial.
The screen displays:
ONE-TOUCH DIAL
[GO BACK]
▶ ONE-TOUCH A
ONE-TOUCH B
ONE-TOUCH C
- 3** Turn Jog Dial to choose “ONE-TOUCH A” to “ONE-TOUCH C”, and then press Jog Dial.

continued

One-touch dialing (continued)

4 Enter the name by turning Jog Dial.

You can enter up to 15 characters.

Turn Jog Dial until the desired character is selected, and then press Jog Dial.

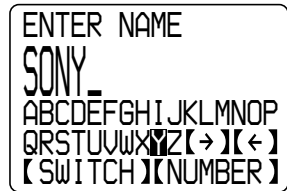

Each press of Jog Dial after choosing “[SWITCH]” switches the characters from upper case letters → lower case letters → numbers and symbols.

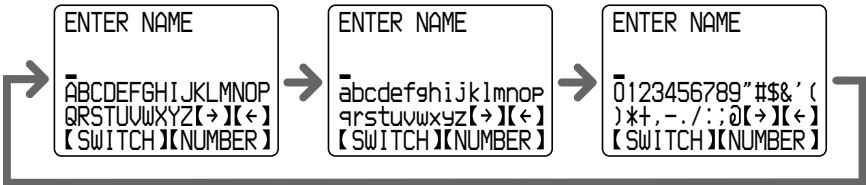

Enter successive characters in the same way.

To enter a “space”, turn Jog Dial to choose “[→]”, and then press Jog Dial.

5 Turn Jog Dial to choose “[NUMBER]”, and then press Jog Dial.

“ENTER NUMBERS” appears on the display.

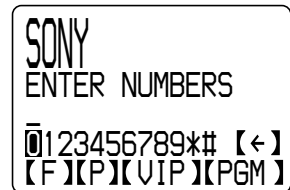

6 Enter the phone number by turning Jog Dial.

You can enter up to 20 digits, including a tone and a pause, each of which is counted as one digit.

Turn Jog Dial until the desired number is selected, and then press Jog Dial.

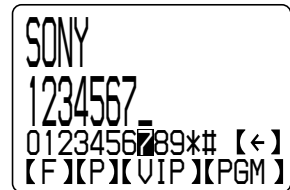

| Icon | Meaning |
|-------|--|
| [F] | Flash can be entered. |
| [P] | Pause can be entered. |
| [VIP] | If [VIP] has been selected, “♪” will appear to the right of the displayed name. The ring type will change when calls are received from VIP registered numbers. |



Enter successive numbers in the same way.
When the phone number of 16 digits or more has been entered, the phone number appears in two lines.

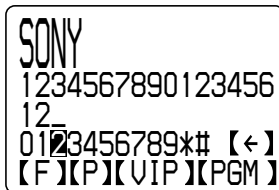

- 7** Turn Jog Dial to choose “[PGM]”, and then press Jog Dial.

You hear a long confirmation beep, and the name and the number are stored.

The display goes off.

Notes

- Names cannot be entered using the dialing keys.
- Do not allow more than 20 seconds to elapse during the operation procedure.

Tips

- When you select “[GO BACK]”, you can return to the previous set display by pressing Jog Dial.
- If you have entered a wrong name or number in step 4 or 6, turn Jog Dial to choose “[←]” then press Jog Dial or press (ERASE) to erase it. Then enter the correct name or number.
- You may press (PROGRAM) instead of doing steps 5 and 7.
- Phone numbers can be entered using the dialing keys in step 6.

To store a number to be dialed via Private Branch Exchange (PBX)

Before entering a phone number in step 6 on page 42, do as follows:

- 1 Enter the outside line access digit (e.g., 9).
- 2 Turn Jog Dial to choose “[P]” and then press Jog Dial, or press (REDIAL/PAUSE).

Changing a stored name and/or phone number

- 1 Display the name you want to change by doing steps 1 to 3 on page 41.

The cursor is at the right of the name.

- 2 Turn Jog Dial to choose “[←]”, then press Jog Dial to erase the characters, and enter the new name.

If you want to change only the number, skip this step.

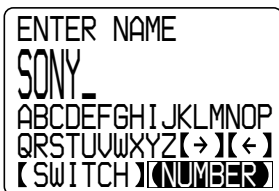

continued

One-touch dialing (continued)

- 3 Turn Jog Dial to choose “[NUMBER]”, and then press Jog Dial.

The cursor is at the right of the phone number.

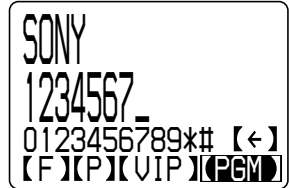

- 4 Turn Jog Dial to choose “[←]”, then press Jog Dial to erase the number, and enter the new number.

If you don't want to change the number, skip this step.

- 5 Turn Jog Dial to choose “[PGM]”, and then press Jog Dial.

You hear a long confirmation beep and the name and/or the number is changed.

Note

The stored record with name and number can be replaced with a new name and number but it is not possible to erase the whole entry at one time.

Tips

- Single character and number can be erased by pressing **(ERASE)** in steps 2 and 4.
- You may press **(PROGRAM)** instead of doing steps 3 and 5.

Making calls with one-touch dialing

- 1 Press **(TALK)** or **(LONG DIST. SAVER)** and wait until “TALK” appears on the display.

- 2 Press one of the ONE-TOUCH DIAL buttons (**(A)** to **(C)**).

The phone number stored on the one-touch dialing button will appear on the display and will be dialed.

To check the phone number before one-touch dialing

While the cordless handset is not in use, press one of the ONE-TOUCH DIAL buttons (**(A)** to **(C)**).

The number stored on the button appears on the display for 20 seconds. To dial the number, press **(TALK)** while the number is displayed.

Phone Directory

You can dial a number by scrolling through the Phone Directory. Both the base phone and the cordless handset can each store up to 50 separate numbers.

Storing phone numbers and names

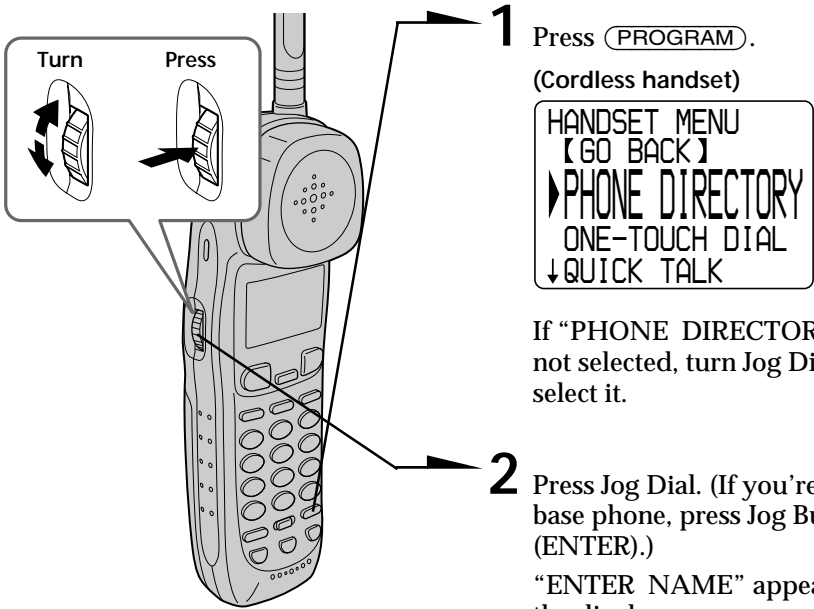

1 Press **PROGRAM**.
(Cordless handset)



If "PHONE DIRECTORY" is not selected, turn Jog Dial to select it.

2 Press Jog Dial. (If you're at the base phone, press Jog Button (ENTER).)
"ENTER NAME" appears on the display.

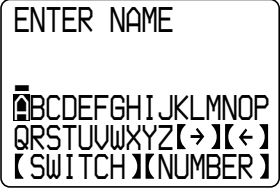

3 Enter the name and the phone number by doing steps 4 to 7 on pages 42 to 43.

Note

If you try to save a 51st phone number, you will hear five short error beeps and "THE MEMORY IS FULL." will be displayed. You cannot store the phone number. To store another phone number, erase one of the stored phone numbers (see page 47).

Changing a stored name and/or phone number

- 1 Display the name you want to change by doing steps 1 to 3 on pages 48 to 49.

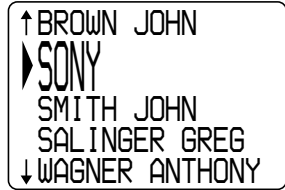

- 2 Press Jog Dial. (If you're at the base phone, press Jog Button (ENTER).)

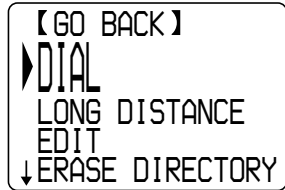

- 3 Turn Jog Dial to choose "EDIT", and then press Jog Dial (or Jog Button (ENTER)).
The cursor is at the right of the name.

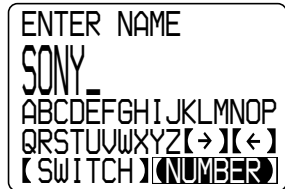

- 4 Change the name and/or the phone number by doing steps 2 to 5 on pages 43 to 44.

Erasing a memory location

To erase the phone number one by one

- 1 Display the name you want to erase by doing steps 1 to 3 on pages 48 to 49.
- 2 Press Jog Dial. (If you're at the base phone, press Jog Button (ENTER).)
- 3 Turn Jog Dial to choose "ERASE DIRECTORY", and then press Jog Dial (or Jog Button (ENTER)).
- 4 Turn Jog Dial to choose "YES", and then press Jog Dial (or Jog Button (ENTER)).
You hear a long confirmation beep and the memory location is erased.

```

↑ BROWN JOHN
▶ SONY
  SMITH JOHN
  SALINGER GREG
↓ WAGNER ANTHONY
  
```

```

【 GO BACK 】
▶ DIAL
  LONG DISTANCE
  EDIT
↓ ERASE DIRECTORY
  
```

```

ERASE DIRECTORY
【 GO BACK 】
▶ NO
  YES
  
```

continued

Phone Directory (continued)

To erase the entire memory at once

- 1 Press **PROGRAM**.
- 2 Turn Jog Dial to choose “MEMORY MANAGE”, and then press Jog Dial. (If you’re at the base phone, press Jog Button (ENTER).)
- 3 Turn Jog Dial to choose “ERASE ALL DIR”, and then press Jog Dial (or Jog Button (ENTER)).
- 4 Turn Jog Dial to choose “ERASE DIRECTORY”, and then press Jog Dial (or Jog Button (ENTER)).
You hear a long confirmation beep and the entire memory is erased.

```
MEMORY MANAGE
【GO BACK】
▶SEND ALL DIR
  ERASE ALL CID
↓ERASE ALL RDL
```

```
ERASE ALL DIR?
【GO BACK】
▶NO
  ERASE DIRECTORY
```

Making calls from the Phone Directory

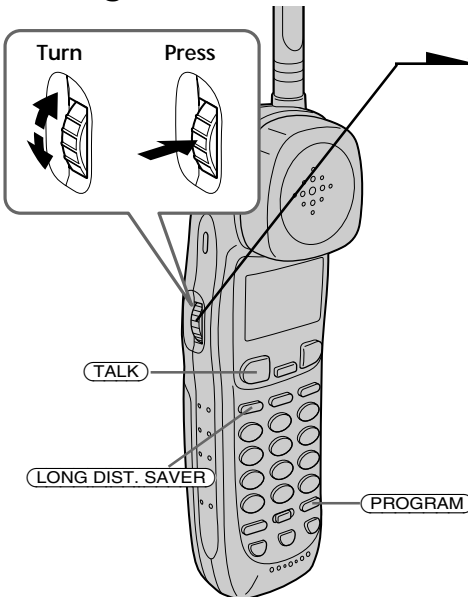

- 1 Press Jog Dial. (If you’re at the base phone, press Jog Button (ENTER).)
“PHONE DIRECTORY” appears on the display.

```
PHONE DIRECTORY
【CALLER ID】
▶【ABC】
  【DEF】
↓【GHI】
```



- 2** Turn Jog Dial to select an alphabet group ([ABC], [DEF]...) which includes the initial character of the name you want to search for, and then press Jog Dial (or Jog Button (ENTER)).
- If a numbers or a symbol is the initial character, select the “[etc]” group.

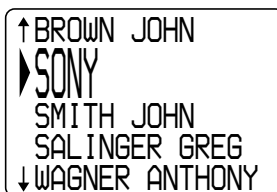

- 3** Select the name you want to call by turning Jog Dial.

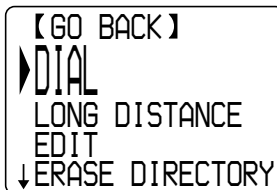

- 4** Press Jog Dial (or Jog Button (ENTER)).



- 5** Turn Jog Dial to choose “DIAL” or “LONG DISTANCE”, and then press Jog Dial (or Jog Button (ENTER)).

The phone number will be dialed.

Note

When the Long Distance Saver function is set to “ACTIVE”, “LONG DISTANCE” can be selected in step 4 (see page 22).

Tips

- When you select “[GO BACK]”, you can return to the previous set display by pressing Jog Dial. (If you’re at the base phone, press Jog Button (ENTER).)
- When you select “[CALLER ID]” in step 1, you can switch to display the Caller ID list (see page 58).
- If there is no data recorded in the selected alphabet group in step 2, the data memory of the next following group will be displayed.
- You may press (TALK) or (LONG DIST. SAVER) on the cordless handset (If you’re at the base phone, pick up the handset from the base phone or press (SPEAKERPHONE) or (LONG DIST. SAVER) to make a call instead of doing steps 4 and 5.

continued

Phone Directory (continued)

Transferring the Phone Directory memory

The Phone Directory memory can be transferred one by one or all at once (with a maximum of 50 numbers) from the cordless handset to the base phone and from the base phone to the cordless handset.

To transfer one phone number from the Phone Directory

- 1 Display the name you want to transfer by doing steps 1 to 3 on pages 48 to 49.

```
↑ BROWN JOHN
▶ SONY
  SMITH JOHN
  SALINGER GREG
↓ WAGNER ANTHONY
```

- 2 Press Jog Dial. (If you're at the base phone, press Jog Button (ENTER).)

```
【 GO BACK 】
▶ DIAL
  LONG DISTANCE
  EDIT
↓ ERASE DIRECTORY
```

- 3 Turn Jog Dial to choose "SEND DIRECTORY", and then press Jog Dial (or Jog Button (ENTER)).

You hear a long confirmation beep and the memory is transferred.

To transfer all phone numbers from the Phone Directory

The Phone Directory receiving the transfer will be totally overwritten.

- 1 Press **PROGRAM**.
- 2 Turn Jog Dial to choose "MEMORY MANAGE", and then press Jog Dial. (If you're at the base phone, press Jog Button (ENTER).)

```
MEMORY MANAGE
【 GO BACK 】
▶ SEND ALL DIR
  ERASE ALL CID
↓ ERASE ALL RDL
```

3 Press Jog Dial again (or Jog Button (ENTER)).

(Cordless handset)

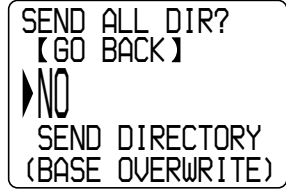

SEND ALL DIR?
【GO BACK】
▶NO
SEND DIRECTORY
(BASE OVERWRITE)

4 Turn Jog Dial to choose “SEND DIRECTORY”, and then press Jog Dial (or Jog Button (ENTER)).

“SENDING...” appears on the display during the transfer.

You hear a long confirmation beep and the entire memory is transferred.

Notes

- If there are already 50 numbers stored in the Phone Directory receiving the transferred number one by one from the other Phone Directory, “CORDLESS HANDSET MEMORY IS FULL.” or “BASEPHONE MEMORY IS FULL.” will appear on the display and five short error beeps will be heard to indicate that the transfer was unsuccessful. To make the transfer possible, erase one of the stored phone numbers existing in the Phone Directory (see page 47).
- If the transfer is unsuccessful, “SEND TO CORDLESS HANDSET FAILED.” or “SEND TO BASEPHONE FAILED.” will appear on the display, and five short error beeps will be heard. Move the cordless handset closer to the base phone, and then start over the procedure.

Switching the phones during a call

You can easily switch between the cordless handset and the base phone without disconnecting the call.

To switch from the base phone to the cordless handset



- 1 Press **(HOLD)** on the base phone.
The call is on hold and “HOLD” appears on the display.
- 2 Pick up the cordless handset from the charger (When Quick talk is set to “USE”; see page 38) or press **(TALK)** or **(HOLD)** on the cordless handset.
You can continue talking to the caller through the cordless handset.

To switch from the cordless handset to the base phone

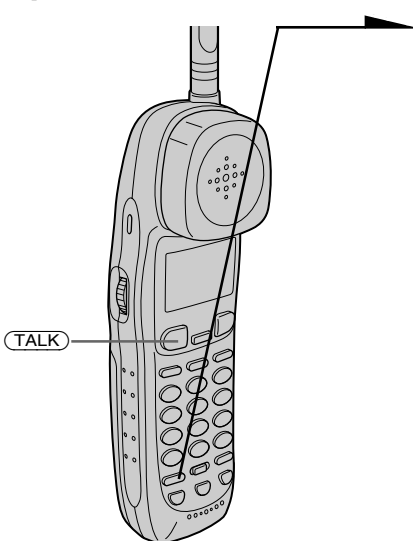

- 1 Press **(HOLD)** on the cordless handset.
The call is on hold and “HOLD” appears on the display.
- 2 Pick up the handset from the base phone or press **(SPEAKERPHONE)** or **(HOLD)** on the base phone.
You can continue talking to the caller through the base phone.

Talking between the phones (Intercom)

You can talk between the base phone and the cordless handset. You can start the intercom from either phone.

To talk from the cordless handset to the base phone

Press **INTERCOM**.

The base phone and cordless handset ring and “** PAGING **” appears on the display.

When a person at the base phone picks up the handset from the base phone or presses **SPEAKERPHONE** or **INTERCOM**, you can talk with each other.

“INTERCOM” appears on the display.

When you are done talking

Replace the cordless handset on the charger or press **OFF** on the cordless handset.

If no one answers the phone

Press **INTERCOM** again.

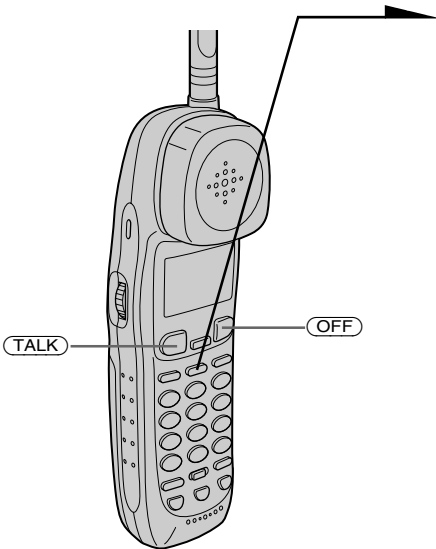

Talking between the phones (Intercom) (continued)

To talk from the base phone to the cordless handset



Press **INTERCOM**.

The base phone and cordless handset ring and “** PAGING **” appears on the display.

When a person at the cordless handset picks up the cordless handset from the charger (When Quick talk is set to “USE”; see page 38) or presses **TALK** or **INTERCOM**, you can talk with each other.

“INTERCOM” appears on the display.

When you are done talking

Replace the handset in the cradle or press **SPEAKERPHONE** on the base phone.

If no one answers the phone

Press **INTERCOM** again.

Notes

- If there is an incoming call during intercom conversation, intercom call will be disconnected, and both the base phone and the cordless handset will ring.
- While talking with an outside caller via the base phone or cordless handset, you cannot make an intercom call. If you press **INTERCOM** on the cordless handset, “BASEPHONE IN USE” appears on the display and you will hear a busy tone.

Tip

You can receive an intercom call on the base phone or the cordless handset even when “RINGER VOL” on the base phone is set to “OFF”, or the RING switch on the cordless handset is set to OFF. The phone will ring at a low level.

Transferring a call

You can transfer a call between the cordless handset and base phone without disconnecting the call.

To transfer from the base phone to the cordless handset



1 Press **INTERCOM** to page the cordless handset.

The call is put on hold on the base phone and the cordless handset rings.
“** PAGING **” appears on the display of both the base phone and cordless handset.

SPEAKERPHONE

2 Pick up the cordless handset from the charger (When Quick talk is set to “USE”; see page 38) or press **TALK** or **INTERCOM** on the cordless handset.

“INTERCOM” appears on the display of both the cordless handset and base phone.

You can talk between the base phone and the cordless handset.

TALK

3 To talk to the caller with the cordless handset, replace the handset in the cradle or press **SPEAKERPHONE** on the base phone.

“TALK” appears on the display of the cordless handset.

If no one answers the phone

Press **INTERCOM** again.

Tips

- You can receive an intercom call on the cordless handset even when the RING switch is set to OFF. The cordless handset will ring at a low level.
- If you have accidentally pressed **HOLD** in step 1, just press **INTERCOM** and you will get the same result as by pressing **INTERCOM** only.

continued

Transferring a call (continued)

To transfer from the cordless handset to the base phone

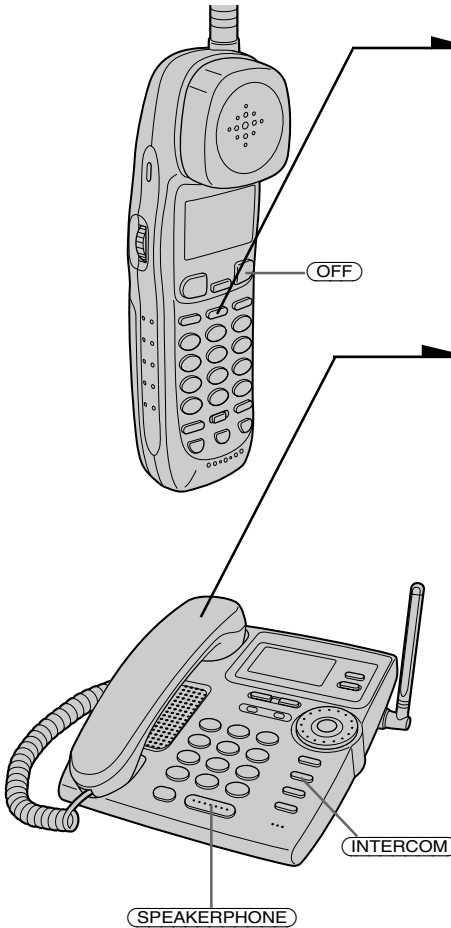

- 1** Press **INTERCOM** to page the base phone.
The call is put on hold on the cordless handset and the base phone rings. “** PAGING **” appears on the display of both the cordless handset and base phone.

- 2** Pick up the handset from the base phone or press **SPEAKERPHONE** or **INTERCOM** on the base phone.
“INTERCOM” appears on the display of both the base phone and cordless handset.
You can talk between the cordless handset and the base phone.

- 3** To talk to the caller with the base phone, replace the cordless handset on the charger or press **OFF** on the cordless handset.
“TALK” or “SPEAKERPHONE” appears on the display of the base phone.

If no one answers the phone

Press **INTERCOM** again.

Tip

You can receive an intercom call on the base phone even when “RINGER VOL” on the base phone is set to “OFF”. The base phone will ring at a low level.

Understanding the Caller ID service

Caller ID allows the caller's phone number to be shown on the display before you answer the call. In order to use this feature, you must first subscribe to Caller ID service. The name of this service may vary depending on your telephone company. To use this feature, be sure to enter the area code (see page 15).

When you receive a call

The phone number appears on the display with the date and time as shown in the following example.

If your Caller ID service includes the caller name service or if the phone number stored in the one-touch dialing, or the Phone Directory matches with the Caller ID data phone number, the caller's name also appears on the display (up to 15 letters). The caller's name will appear by the name stored in the one-touch dialing or Phone Directory if you receive a call from a phone number which is stored on one of the ONE-TOUCH DIAL buttons or in the Phone Directory.

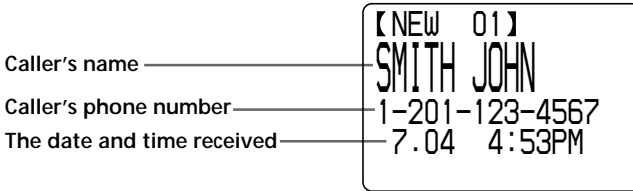

When you answer the call, the Caller ID display changes to the "TALK" or "SPEAKERPHONE" display.

Notes

- The caller's phone number and/or name will not appear in the following cases:
 - "OUT OF AREA": when the call is made through a telephone company which does not offer Caller ID service (including international calls).
 - "PRIVATE": when the call is "blocked". For privacy reasons, many states allow callers the option to prevent his or her telephone data from being displayed on the other party's Caller ID display.
- If the call is from an office which uses multiple lines, the displayed phone number may not match the number you use to call the extension.

About the memory match function

The name stored in the one-touch dialing or Phone Directory will appear on the display if you receive a call from a phone number which is stored on one of the ONE-TOUCH DIAL buttons (see page 41) or in the Phone Directory (see page 45).

In addition, the ringer sound will change to a higher tone from the second ring and "♪" will appear to the right of the displayed name if you receive a call from a VIP registered phone number on the base phone or the cordless handset.

Note

The memory match function does not work with "OUT OF AREA" or "PRIVATE" calls; and it may not work with calls made from an office which uses multiple lines because the number does not always match the one you stored in this phone.

Looking at the Caller ID list

The phone stores the data of the last 100 calls received including “OUT OF AREA” and “PRIVATE” calls. It keeps track of all calls received; even if they were not answered.

Viewing the Caller ID list

You can look through the Caller ID list on both the base phone and the cordless handset to check the phone number and/or name of the calls received.

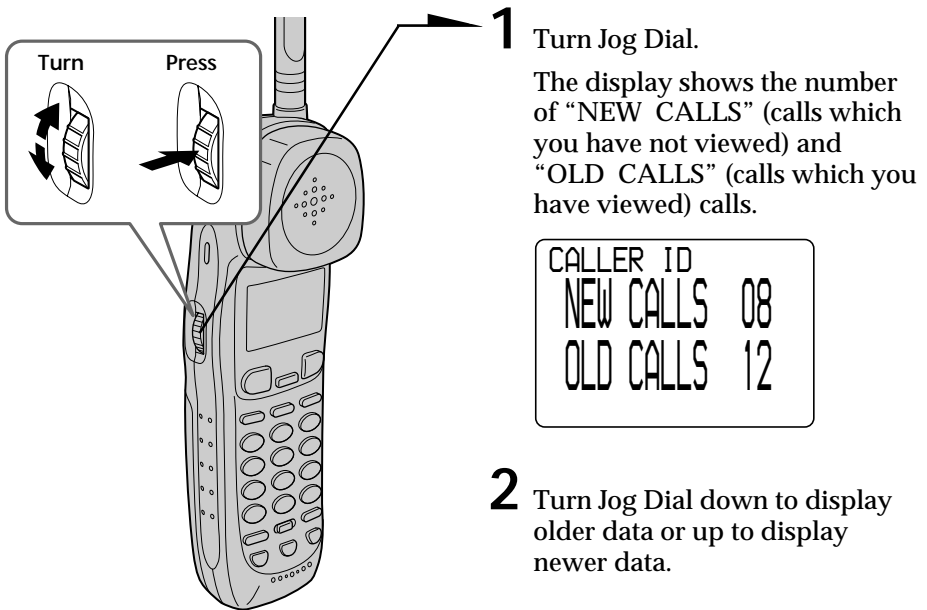

Notes

- If a 101st call is received, the oldest data is automatically erased.
- When you have checked all data, “END OF LIST” appears.

Tip

If there is a “NEW” data, the NEW CALL lamp of the base phone flashes.

The number of “NEW CALLS” can be confirmed with the standby mode display of the base phone.



Erasing data from the Caller ID list

Old data will be erased automatically when a 101st call comes in, but you can also manually erase unnecessary data one by one or erase the entire list.

To erase the phone number one by one

- 1 Display the phone number you want to erase from the Caller ID list (see page 58).

- 2 Press Jog Dial. (If you're at the base phone, press Jog Button (ENTER).)

- 3 Turn Jog Dial to choose "ERASE CALLER ID", and then press Jog Dial (or Jog Button (ENTER)).

- 4 Turn Jog Dial to choose "YES", and then press Jog Dial (or Jog Button (ENTER)).
 You hear a long confirmation beep and the data is erased.

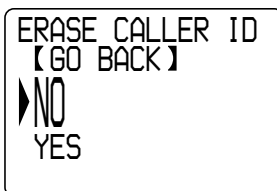
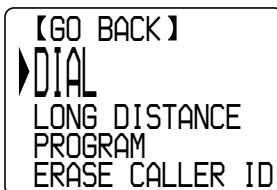
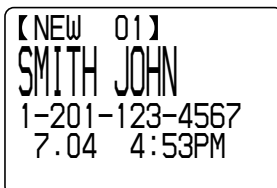

Note

Do not allow more than 20 seconds to elapse during the operation procedure.

Tip

When you select "[GO BACK]", you can return to the previous set display by pressing Jog Dial. (If you're at the base phone, press Jog Button (ENTER).)

continued

Looking at the Caller ID list (continued)

To erase the entire list at once

Entire Caller ID list deletion can only be made on the base phone.

Note that Caller ID data in the list that has not been viewed will also be erased.

1 Press **PROGRAM**.

2 Turn Jog Dial to choose “MEMORY MANAGE”, and then press Jog Button (ENTER).



MEMORY MANAGE
【GO BACK】
▶ SEND ALL DIR
ERASE ALL CID
↓ ERASE ALL RDL

3 Turn Jog Dial to choose “ERASE ALL CID”, and then press Jog Button (ENTER).

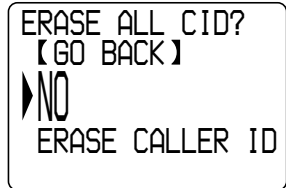

ERASE ALL CID?
【GO BACK】
▶ NO
ERASE CALLER ID

4 Turn Jog Dial to choose “ERASE CALLER ID”, and then press Jog Button (ENTER).

You hear a long confirmation beep and the entire list is erased.

Note

Do not allow more than 20 seconds to elapse during the operation procedure.

Tip

When you select “[GO BACK]”, you can return to the previous set display by pressing Jog Button (ENTER).

Using the Caller ID list

By using the Caller ID list, you can call back a phone number from the Caller ID list easily, or store numbers from the Caller ID list into the Phone Directory.

Calling back a number from the Caller ID list

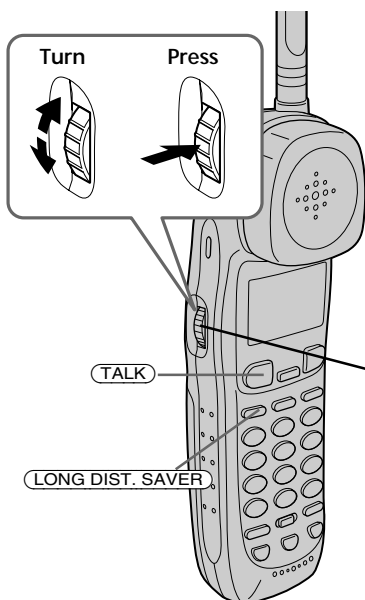

- 1 Display the phone number you want to call from the Caller ID list (see page 58).

```
【NEW 01】  
SMITH JOHN  
1-201-123-4567  
7:04 4:53PM
```

- 2 Press Jog Dial. (If you're at the base phone, press Jog Button (ENTER).)

```
【GO BACK】  
▶DIAL  
LONG DISTANCE  
PROGRAM  
ERASE CALLER ID
```

- 3 Turn Jog Dial to choose "DIAL" or "LONG DISTANCE", and then press Jog Dial (or Jog Button (ENTER)).

The phone automatically dials the displayed number.

Using the Caller ID list (continued)

Notes

- When the Long Distance Saver function is set to “ACTIVE”, “LONG DISTANCE” can be selected in step 2 (see page 22).
- If the area code is not entered, “PLEASE ENTER AREA CODE” will appear on the display, and you will not be able to call back. Enter the area code (see page 15).
- Do not allow more than 20 seconds to elapse during the operation procedure.
- If the number displayed in step 1 is not the one you should call back, you can change the number of digits of the phone number as described on page 64.
- If the phone is connected to a Private Branch Exchange (PBX), you may not be able to call back from the Caller ID list because an outside line access digit is necessary.

Tips

- You may press **(TALK)** or **(LONG DIST. SAVER)** on the cordless handset (If you're at the base phone, pick up the handset from the base phone or press **(SPEAKERPHONE)** or **(LONG DIST. SAVER)**) to make a call instead of doing steps 2 and 3.
- When you select “[GO BACK]”, you can return to the previous set display by pressing Jog Dial. (If you're at the base phone, press Jog Button (ENTER).)

Storing a number of the Caller ID list into the Phone Directory

- 1 Display the name and phone number you want to store from the Caller ID list (see page 58).

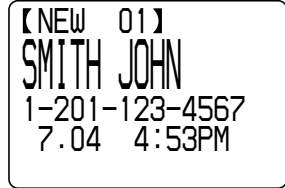

- 2 Confirm the number and press Jog Dial. (If you're at the base phone, press Jog Button (ENTER).)

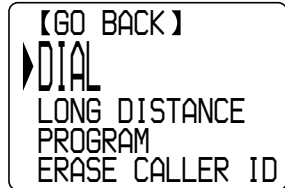

- 3 Turn Jog Dial to choose "PROGRAM", and then press Jog Dial (or Jog Button (ENTER)).

The cursor is at the right of the name.

Enter or change the name, if necessary (see page 43).

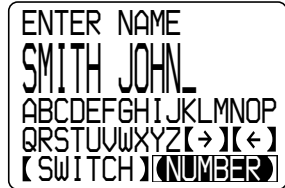

- 4 Turn Jog Dial to choose "[NUMBER]", and then press Jog Dial (or Jog Button (ENTER)).

The cursor is at the right of the phone number.

Enter or change the phone number, if necessary (see page 44).

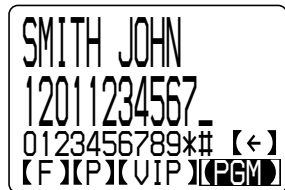

- 5 Turn Jog Dial to choose "[PGM]", and then press Jog Dial (or Jog Button (ENTER)).

You hear a long confirmation beep and the name and number are stored.

continued

Using the Caller ID list (continued)

Notes

- If the area code is not entered, "PLEASE ENTER AREA CODE" will appear on the display, and you will not be able to store into the Phone Directory. Enter the area code (see page 15).
- Do not allow more than 20 seconds to elapse during the operation procedure.
- If the number displayed in step 1 is not the one you should store, you can change the number of digits of the phone number as described below.
- If the phone is connected to a Private Branch Exchange (PBX), you may need to add an outside line access digit.

Tips

- When you select "[GO BACK]", you can return to the previous set display by pressing Jog Dial. (If you're at the base phone, press Jog Button (ENTER).)
- You may press (PROGRAM) instead of doing steps 4 and 5.

To change the number of digits of the phone number

If the number of digits of the phone number in the Caller ID list is different from the actual phone number, you need to adjust the number of digits of the phone number to call back or store into the Phone Directory.

- 1 While the phone number from the Caller ID list is displayed, press (#) repeatedly until the phone number with the correct number of digits appears on the display.

Each time you press (#), the number of digits changes as follows:

When the home area code and the local area code do not match

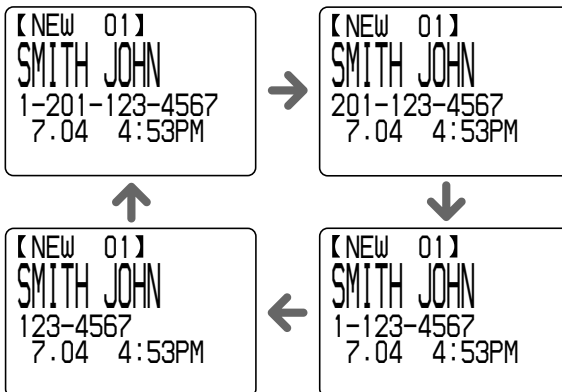

When the home area code matches

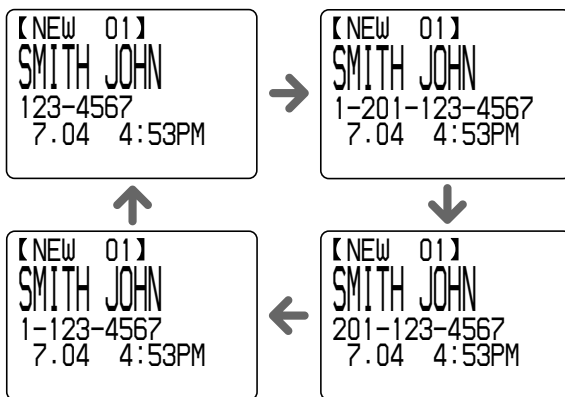

When the local area code matches

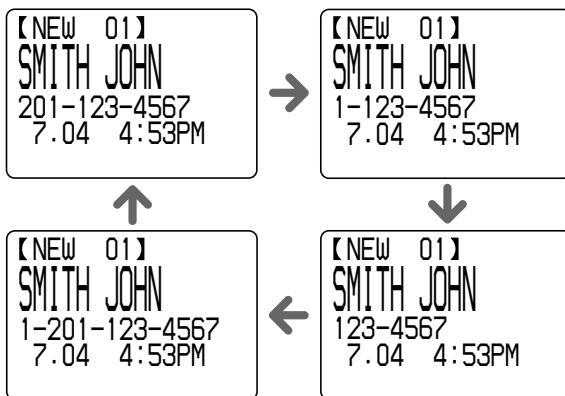

2 Continue the operation to call or store the phone number with the correct number of digits (pages 61 and 63).

Notes

- You need to adjust the number of digits each time you call back from the Caller ID list as the changes to the Caller ID data is not stored in memory.
- You may not be able to change the number of digits depending on the Caller ID data.

Using “Caller ID with call waiting” service

This telephone is compatible with the “Caller ID with call waiting” service. Make sure that your telephone company offers this service.

Like the basic Caller ID service, you need to subscribe to “Caller ID with call waiting” in order to use this service.

Even though you may have already subscribed to “Caller ID” and “call waiting” as two separate services, you need to request a subscription to “Caller ID with call waiting” as a single service.

This is a new service that combines the two services.

Even though you now have a “Caller ID with call waiting” compatible phone, unless you subscribe to the combined “Caller ID with call waiting” service, you will not be able to see the name and number of the second caller.

When a new call comes in while you are talking, the caller’s name and/or phone number of the new call appears on the display for about 20 seconds.

To switch to another caller



1 To switch to the new caller, press **CALL WAITING/FLASH**.

2 To switch back to the first caller, press **CALL WAITING/FLASH** again.

Tip

When the “Caller ID with call waiting” service is set to “INACTIVE”, you cannot use this service even if you have subscribed to “Caller ID with call waiting” service (see page 19).

Using voice mail service

If you subscribe to your telephone company's message service which includes this feature, the display will show that you have messages waiting to be retrieved.

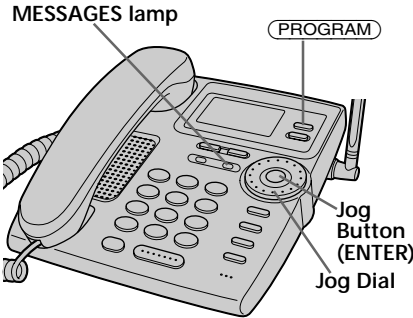

If you have messages

“MESSAGES WAITING” appears on the display of both the cordless handset and base phone and the MESSAGES lamp on the base phone flashes.

The display and the MESSAGES lamp will go off when you retrieve your messages.

Note

You cannot use this feature, if you have not subscribed to your telephone company's message service.

For details on the availability of this service, please ask your telephone company.

Tip

When the voice mail service is set to “INACTIVE”, the MESSAGES lamp does not function even if you have subscribed to voice mail service (see page 23).

If the MESSAGES lamp remains flashing

If this lamp does not go off (e.g. When you retrieve your messages with other phones), you can go off the lamp manually.

To go off the MESSAGES lamp

- 1 Press **PROGRAM**.
- 2 Turn Jog Dial to choose “BASE SETTINGS”, and then press Jog Button (ENTER).
- 3 Turn Jog Dial to choose “MESSAGES LAMP”, and then press Jog Button (ENTER).
- 4 Press Jog Button (ENTER).

The MESSAGES lamp on the base phone goes off, and you hear a long confirmation beep.



continued

Using voice mail service (continued)

If you move or change your telephone company

Message waiting signals are sent in one of two ways: FSK signaling or “stutter” signaling (Your telephone company can provide you with more information about your service).

The first time this phone receives a voice mail message, it will set itself to the FSK service and will lock out the stutter service if your telephone company is in FSK service.

When you move or change your telephone company, you need to perform the following procedure. The phone will return to ready state for either FSK or stutter dial tone voice mail recognition.

To reset this phone

- 1 Perform steps 1 and 3 on page 67.
- 2 Turn Jog Dial to choose “RESET”, and then press Jog Button (ENTER).

You hear a long confirmation beep and the phone is reset.



Mounting the base phone on a wall

1

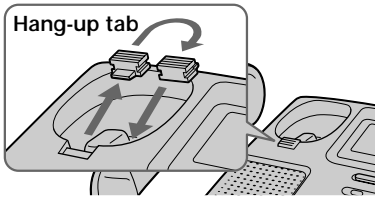

1

Reverse the hang-up tab.

2

Plug the telephone line cord to the LINE jack and the AC power adaptor to the DC IN 11V jack, and hook the cords. Use the shorter cord for mounting.

2

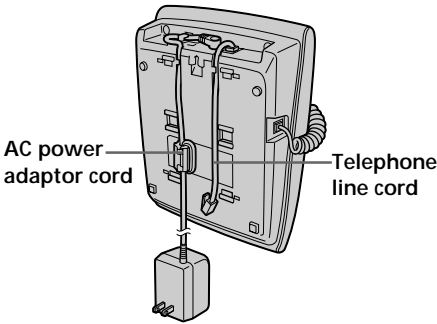

3

Attach the wall bracket to the center of the base phone. Align the Δ marks of the wall bracket with those of the base phone.

3

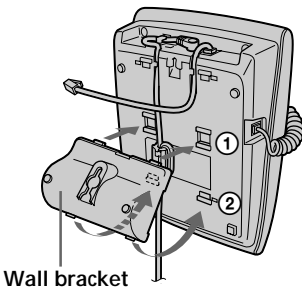

4

Plug the telephone line cord to the telephone outlet, and hook the base phone to the wall plate.

5

Plug the AC power adaptor to an AC outlet. Then raise the antenna so that it points towards the ceiling.

4, 5

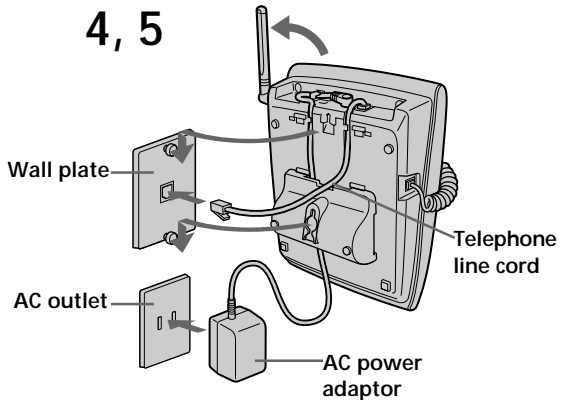

Tip

To remove the wall bracket, press the lower tabs.

Carrying the cordless handset by the belt clip

You can hang the cordless handset on the belt by attaching the belt clip to the cordless handset.

Attaching the belt clip

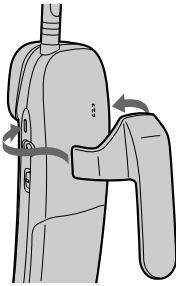

Press the belt clip to the cordless handset. Make sure that the side tabs click and go into the holes on the sides of the cordless handset.

Note

To prevent the cordless handset from dropping, make sure that each tab is completely inserted.

Detaching the belt clip

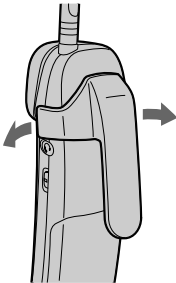

While pressing the back of the belt clip, pull the sides one by one until the tabs come off from the holes.

Note

Remove the belt clip carefully to avoid breaking your fingernails.

Using the headset

You can talk on the cordless handset without using your hands by connecting a headset (optional) to the  (HEADSET) jack on the cordless handset.

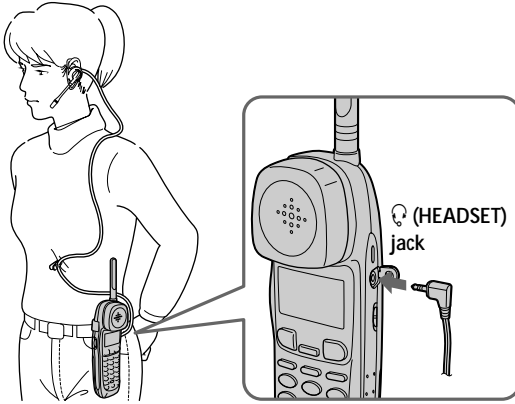

Notes on power sources

On battery pack

- Store the battery pack at a temperature between 41°F (5°C) and 95°F (35°C) for best performance.
- If you do not use the cordless handset for a long period of time, remove the battery pack after charging for more than 12 hours.

On power failure

During a power interruption, you cannot make or receive calls.

For the customers in the USA

RECYCLING NICKEL-CADMIUM BATTERIES

Nickel-Cadmium batteries are recyclable. You can help preserve our environment by returning your unwanted batteries to your nearest point for collection, recycling or proper disposal.



Note: In some areas the disposal of nickel-cadmium batteries in household or business trash may be prohibited.

RBRC (Rechargeable Battery Recycling Corporation) advises you about spent battery collection by the following phone number.

Call toll free number: 1-800-822-8837
(United States and Canada only)

Caution: Do not handle damaged or leaking nickel-cadmium batteries.

Maintenance

- Clean the cabinets with a soft cloth slightly moistened with water or a mild detergent solution. Do not use any type of abrasive pad, scouring powder or solvent such as alcohol or benzine as they may damage the finish of the cabinet.
- If the charge terminals of the charger and cordless handset are soiled, wipe them with a soft cloth.

If you have any questions or problems concerning your phone, please consult your nearest Sony dealer.

Troubleshooting

If you've experienced any of the following difficulties while using your phone, use this troubleshooting guide to help you remedy the problem. Should any problem persist, consult your nearest Sony dealer.

| | Symptom | Remedy |
|------------------------------|--|---|
| Making calls | You hear five short error beeps when you press (TALK) . | <ul style="list-style-type: none"> • Make sure you have set up the base phone correctly (page 10). • Move the cordless handset closer to the base phone. |
| | You hear no dial tone. | <ul style="list-style-type: none"> • Make sure the telephone line cord is securely connected to the telephone outlet. • Make sure the battery is fully charged (page 13). |
| | The phone does not connect at all, even though the number you dial is correct. | <ul style="list-style-type: none"> • Make sure the dialing mode is set correctly (page 12). |
| | The phone does not redial correctly. | <ul style="list-style-type: none"> • Make sure the dialed number is really the one you want to dial. |
| | You cannot hear anything from the speakerphone. | <ul style="list-style-type: none"> • During phone conversation, press (VOLUME) (+) on the base phone to increase the speakerphone volume. |
| Long Distance Saver function | (LONG DIST. SAVER) does not function. | <ul style="list-style-type: none"> • Make sure that the Long Distance Saver function is set to "ACTIVE" (page 22). |
| | Even by pressing (LONG DIST. SAVER) , the long distance call is not being made. | <ul style="list-style-type: none"> • Make sure that the registered access number is correct and if the service provider needs any registration beforehand. |
| Receiving calls | The cordless handset does not ring. | <ul style="list-style-type: none"> • Set the RING switch on the cordless handset to ON. • The battery may be weak. Charge the battery for more than 12 hours (page 13). • Make sure you have set up the base phone correctly (page 10). • Move the cordless handset closer to the base phone, and confirm a dial tone is heard by pressing (TALK) on the cordless handset. |
| | The base phone does not ring. | <ul style="list-style-type: none"> • Press (VOLUME) (+) on the base phone to increase the ringer volume. • Make sure the telephone line cord is securely connected to the telephone outlet. |

| | Symptom | Remedy |
|---------------------------------------|---|---|
| During conversation | You hear interference during conversation. | <ul style="list-style-type: none"> • Move the cordless handset closer to the base phone. • Place the base phone away from noise sources (page 10). |
| | You hear a beep every second during a conversation and “F” appears on the display. | <ul style="list-style-type: none"> • This is the out-of-range alarm. Move the cordless handset closer to the base phone within 30 seconds. |
| | You hear a beep twice per second and “BATTERY LOW” appears on the display. | <ul style="list-style-type: none"> • The battery is weak. Charge the battery for more than 12 hours (page 13). |
| One-touch dialing/ Phone Directory | You hear five short error beeps and cannot store a number on a one-touch dial or in the Phone Directory. | <ul style="list-style-type: none"> • Make sure you follow the procedure for storing the number correctly (pages 41, 45). |
| | You hear five short error beeps when you try to make a one-touch dial call. | <ul style="list-style-type: none"> • You have pressed a one-touch dialing button on which no phone number has been stored. |
| | One-touch dialing or Phone Directory dialing is incorrect. | <ul style="list-style-type: none"> • Store the correct number (pages 41, 45). |
| Intercom | The cordless handset does not ring when you use the intercom from the base phone, and the base phone does not ring when you use the intercom from the cordless handset. | <ul style="list-style-type: none"> • The battery may be weak. Charge the battery for more than 12 hours (page 13). • Move the cordless handset closer to the base phone. • Place the base phone away from noise sources (page 10). |
| | When pressing (INTERCOM) on the cordless handset, you hear a busy tone and cannot make an intercom call. | <ul style="list-style-type: none"> • The base phone is being used to converse with an outside caller. |

continued

Troubleshooting (continued)

| Symptom | Remedy |
|---|---|
| The caller's name and/or phone number does not appear on the display. | <ul style="list-style-type: none"> • Make sure you have subscribed to Caller ID service. • Caller ID service may not work when the phone is connected to a Private Branch Exchange (PBX). • The call is made through company which does not offer Caller ID service. "OUT OF AREA" will appear on the display. • The call was "blocked." "PRIVATE" will appear on the display. • You have answered the call while "** RINGING **" was displayed. Please answer the call after the second ringer sound. |
| The caller's name and/or phone number does not appear on the display during call waiting. | <ul style="list-style-type: none"> • Make sure you have subscribed to "Caller ID with call waiting" service (page 66). • Make sure the "Caller ID with call waiting" service is set to "ACTIVE" (page 19). • Make sure nobody is talking with another phone on the same telephone line. |
| You cannot dial the number from the Caller ID list. | <ul style="list-style-type: none"> • Make sure you entered your area code correctly (page 15). • You may need to change the number of digits of the phone number (page 64). • This function may not work when the phone is connected to a Private Branch Exchange (PBX). |
| The memory match function does not work. | <ul style="list-style-type: none"> • If the call is from an office which uses multiple lines, the phone number may not match the number you put in the memory. • If you have stored phone number with an outside line access digit on a one-touch dial or in the Phone Directory because the phone is connected to a Private Branch Exchange (PBX), the phone number will not match the Caller ID data. • If you have stored phone number of less than 7 digits on a one-touch dial or in the Phone Directory, the phone number will not match the Caller ID data. |
| You cannot use voice mail service. | <ul style="list-style-type: none"> • Make sure you have subscribed to voice mail service (page 67). |
| The MESSAGES lamp does not function even if you have subscribed to voice mail service. | <ul style="list-style-type: none"> • If you move or change your telephone company, reset this phone (page 68). • Make sure that the voice mail service is set to "ACTIVE" (page 23). |

Caller ID

Troubleshooting

If you've experienced any of the following difficulties while using your phone, use this troubleshooting guide to help you remedy the problem. Should any problem persist, consult your nearest Sony dealer.

| | Symptom | Remedy |
|------------------------------|--|---|
| Making calls | You hear five short error beeps when you press (TALK) . | <ul style="list-style-type: none"> • Make sure you have set up the base phone correctly (page 10). • Move the cordless handset closer to the base phone. |
| | You hear no dial tone. | <ul style="list-style-type: none"> • Make sure the telephone line cord is securely connected to the telephone outlet. • Make sure the battery is fully charged (page 13). |
| | The phone does not connect at all, even though the number you dial is correct. | <ul style="list-style-type: none"> • Make sure the dialing mode is set correctly (page 12). |
| | The phone does not redial correctly. | <ul style="list-style-type: none"> • Make sure the dialed number is really the one you want to dial. |
| | You cannot hear anything from the speakerphone. | <ul style="list-style-type: none"> • During phone conversation, press (VOLUME) (+) on the base phone to increase the speakerphone volume. |
| Long Distance Saver function | (LONG DIST. SAVER) does not function. | <ul style="list-style-type: none"> • Make sure that the Long Distance Saver function is set to "ACTIVE" (page 22). |
| | Even by pressing (LONG DIST. SAVER) , the long distance call is not being made. | <ul style="list-style-type: none"> • Make sure that the registered access number is correct and if the service provider needs any registration beforehand. |
| Receiving calls | The cordless handset does not ring. | <ul style="list-style-type: none"> • Set the RING switch on the cordless handset to ON. • The battery may be weak. Charge the battery for more than 12 hours (page 13). • Make sure you have set up the base phone correctly (page 10). • Move the cordless handset closer to the base phone, and confirm a dial tone is heard by pressing (TALK) on the cordless handset. |
| | The base phone does not ring. | <ul style="list-style-type: none"> • Press (VOLUME) (+) on the base phone to increase the ringer volume. • Make sure the telephone line cord is securely connected to the telephone outlet. |

Specifications

General

Spread method

Direct-Sequence Spread-Spectrum

Access method

FDMA-TDD

Frequency band

902 - 928 MHz

Operating channel

23 channels

Dial signal

Tone, 10 PPS (pulse) selectable

Supplied accessories

See page 9.

Cordless handset

Power source

Rechargeable battery pack BP-T24

Battery life

Standby: Approx. 6 days

Talk: Approx. 5 hours

Battery charging time

Approx. 12 hours

Dimensions

Approx. 58 x 185.4 x 48 mm (w/h/d),
antenna excluded
(approx. 2 ³/₈ x 7 ³/₈ x 1 ¹⁵/₁₆ inches)

Antenna: Approx. 72 mm
(approx. 2 ⁷/₈ inches)

Mass

Approx. 260 g
(approx. 9.2 oz), battery included

Base phone

Power source

DC 11V from AC power adaptor
AC-T107

Dimensions

Approx. 175 x 60 x 214 mm (w/h/d),
antenna excluded
(approx. 7 x 2 ³/₈ x 8 ¹/₂ inches)

Antenna: Approx. 112 mm
(approx. 4 ¹/₂ inches)

Mass

Approx. 580 g
(approx. 1 lb 4 oz), wall bracket excluded

Charger

Power source

DC 6V from AC power adaptor

Dimensions

Approx. 72.5 x 60 x 85 mm (w/h/d)
(approx. 2 ⁷/₈ x 2 ³/₈ x 3 ³/₈ inches)

Mass

Approx. 204 g (approx. 7.2 oz)

Design and specifications are subject to
change without notice.

Index

A

- Adjusting volume
 - cordless handset volume 31, 38
 - handset volume 34, 39
 - speakerphone volume 34, 39
- Area code 15

B

- Battery pack
 - charging 13
 - duration 14

C

- Call waiting service 31, 38
- Caller ID 57
 - Caller ID list 58
 - calling back 61
 - memory match function 57
 - storing in Phone Directory 63
- Caller ID with call waiting 19, 66
- Carrying the cordless handset by the belt clip 70
- Connection 11

D

- Dialing mode
 - choosing 12
 - switching to the tone temporarily 31
- Directory
 - Phone Directory 45

E, F, G

- Erasing
 - Caller ID data 59
 - phone numbers dialed 36
 - Phone Directory 47

H

- Headset 31, 37, 71
- Hold 31, 38
- Home area code 15

I, J, K

- Identifying the parts 26
- Intercom 53

L

- Local area code 17
- Location, base phone 10
- Long Distance Saver function 21, 31

M, N

- Making calls 30
- Memory match function 57
- Mounting the base phone on a wall 69

O

- One-touch dialing 41
- OUT OF AREA 57

P, Q

- Package contents 9
- Phone Directory 45
- PRIVATE 57
- Pulse dialing 12

R

- Receiving calls 37
- Redialing 35
- Ringer
 - RING switch 38

S

- Setting up
 - base phone 10
 - cordless handset 13
- Setting up the phone services 19
- Speakerphone 34
- Storing Caller ID data in Phone Directory 63
- Switching phones during a call 52

T, U

- Talking between the phones 53
- Tone dialing
 - dialing mode 12
 - switching to 31
- Transferring a call 55
- Troubleshooting 74

V, W, X, Y, Z

- Voice mail service 67
- Volume
 - cordless handset 31, 38
 - handset 34, 39
 - speakerphone 34, 39

For the customers in the USA

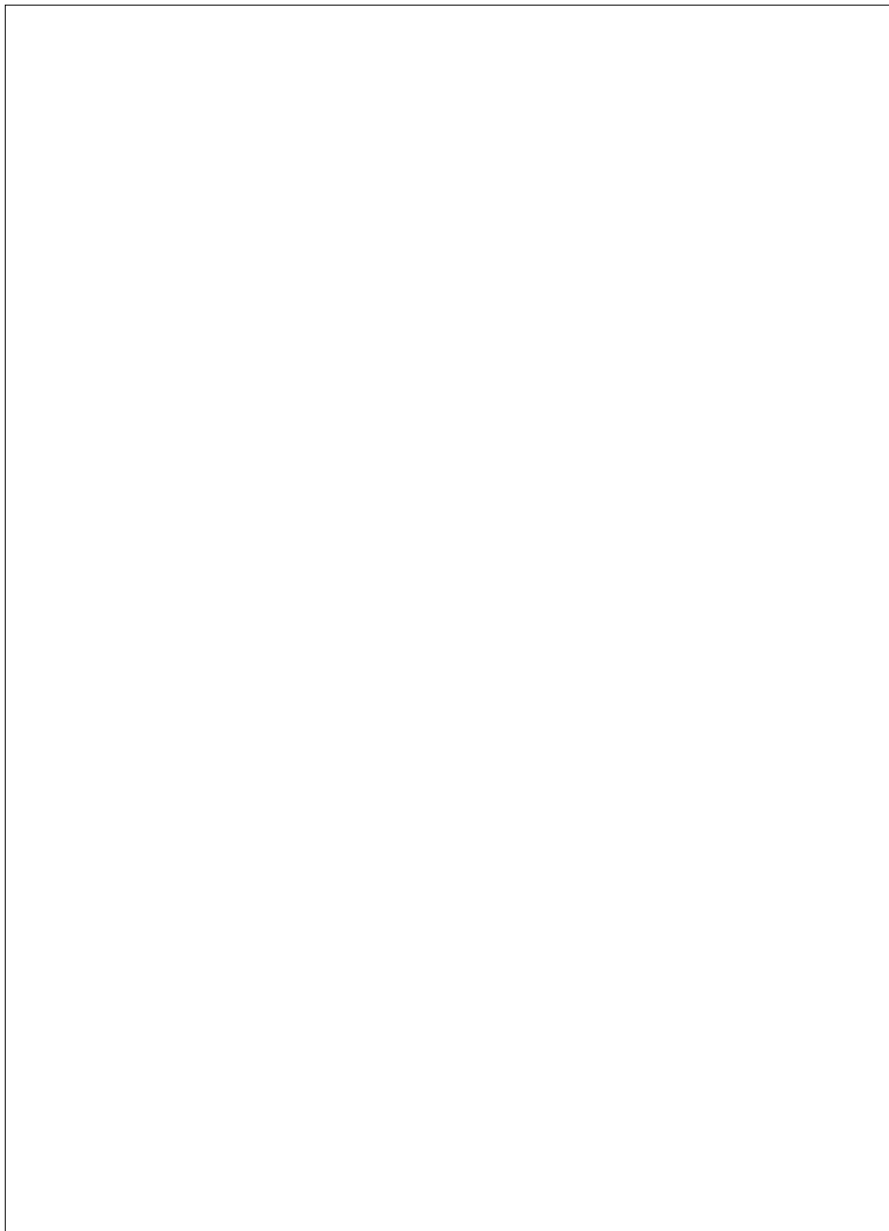

Be sure to save the receipt and attach it to your WARRANTY card when having your equipment repaired at an authorized Sony service station.

For online product registration, please contact
www.sony.com/productregistration